



Property Valuation

Lesson 14

Property Measurement and Calculation Procedures

45 Hour Louisiana Post-Licensing

PROPERTY MEASUREMENT

UNDERSTANDING ANSI-Z765

STANDARDS FOR SINGLE FAMILY RESIDENTIAL MEASUREMENT

- Living Area Inconsistency
- Comparative Unit or Units of Comparison
- National Measurement Standard
- Relating ANSI Terminology to MLS Terminology

Living Area Inconsistency

The standards for measuring residential properties have been often guided by the users of the information such as government agencies and/or guided by norms expected by the professionals operating in a geographic market area. As a result, there was and still remains today inconsistencies amongst various professions involved in single family residential measurement and area calculation, in addition to variances within the same profession operating in different market areas.

Real estate agents and brokers are subject to the requirements of various professional boards; appraisers are subject to the guidelines of their users such as FHA, VA, Fannie Mae and Freddie Mac; architects are subject to their professional requirements; property managers subject to their specific requirements; home builders are subject to their specific requirements; etc. As you can see, there are numerous professions and organizations that compute and rely upon the labeling of area, and the calculation of area in a single family residence. The problem is the inconsistency in methodology and ultimately the outcome of the computations, often identified utilizing the same terminology, i.e. living area.

For example, when one searches for definitions of living area, several different definitions appear along with a combination of qualifiers. Some definitions lump the term “living area” with “gross”, some with “net”. Even with the qualifiers in place, the definitions vary.

Per the U.S. Air Force, **Net Living Area** is: Generally defined as the floor area of the living room, bedroom, bathroom, and kitchen/dining area, measured from the inside face of the room walls.

Per AccuCoverage (insurance agency), **Living Area** is: The size of a home (in square feet) based upon the exterior dimensions. This total should include the square footage of the main home as well as the square footage of the wing or addition if one has been specified.

Per the Appraisal Institute's *Dictionary of Real Estate Appraisal*, 5th Edition, **Gross Living Area** is: Total area of finished, above-grade residential space; calculated by measuring the outside perimeter of the structure and includes only finished habitable, above-grade living space (finished basements and attic areas are not generally included in total gross living area. Local practices; however, may differ).

You can see from the definitions presented, one of the primary problems is in the inconsistency of where to measure: inside vs. outside vs. middle of the wall. Other inconsistencies exist in defining the degree of finishes needed to be considered living area, the handling of stairs, the ceiling height requirements, accessibility, ventilation requirements, etc. Additionally, there is the issue of the proper tools needed to compute area and just how accurate does one have to be! The definitions themselves even acknowledge that there is variance based upon “local practices”. Such a variety of definitions and measurement techniques produce an inability to accurately communicate property size information between professionals of various professions and members of the same profession in different locations.

In Louisiana, several Realtor boards teach measurement techniques and provide a “living area” definition as a means of creating consistency between members. A sample definition of living area from a Louisiana Board is as follows:

Living Area is: our market term used to describe the finished, heated and cooled habitable contiguous area of a house measured from exterior walls.

This definition provided consistency between Realtors in the board’s market area, however, did not provide for communication nationwide. For instance, the “heated and cooled” requirement is reasonable for south Louisiana, however, to mandate HVAC as a living area requirement to a property owner in Colorado is not reasonable. You can see how different “market areas” produce different requirements for living area based upon climate. Thus, a real estate agent/broker in south Louisiana is using the same term to communicate area, but definitions differ. The inconsistency in describing and computing area limits the ability to effectively communicate and market properties outside of the real estate’s agent’s market area.

Comparative Unit or Units of Comparison

Units of Comparison, per *The Dictionary of Real Estate Appraisal, 5th ed.*,

The components into which a property may be divided for purposes of comparison, e.g., price per square foot, front foot, cubic foot, room, bed, seat, apartment unit.

Pricing a property most often relies upon comparative unit methodology. Comparative unit methodology is detailed in the Property Pricing module, but is also addressed here to explain and support the need for consistent and accurate area calculation.

Without the ability to break down the comparable sales by a comparative unit, the real estate agent/broker data is limited to gross sales price. For example, when asked to list a house in a certain neighborhood, a necessary step is to gather the most recent sales transactions of similar properties. This is considered researching transactional data. The best comparable sales are the most recent transactions of properties that are the most similar to the subject in location and physical features.

To continue, let’s say that there are 15 transactions in the subject’s neighborhood that have occurred in the last 6 months. The properties are similar and range in sales price from \$200,000 to \$400,000. Without utilizing comparative unit methodology, your pricing of the subject is based upon sales price. However, it is difficult to realize why one buyer paid \$200,000, one buyer paid \$250,000, one buyer paid \$300,000 and another paid \$400,000. Comparative unit methodology allows a real estate agent/broker to break down the raw sales data into something more meaningful and isolate the motivation of price paid in each sale.

There are a variety of units that could motivate a buyer to pay a price for a property. In income producing properties the comparative unit is often related to sales price/income. In single family dwellings sold for owner occupancy, the comparative unit is often related to size. The real estate agent/broker’s job is to determine the best and most consistent to apply to the subject property. The analysis begins with breaking down the sales price paid, by a unit that is known about the comparable sales and the subject. For example: Sales Price / Square Feet of Living Area. If the result of the application to each sale is a narrowing of the range, then it is reasonable that the agent has isolated a potential motivation of price between buyer and seller. The tightest range is created by the strongest comparative unit, or the unit that indicates what motivated the buyer to pay the price for the property. In many cases, price paid for a single family residential dwelling is based upon unit value per square foot of living area. This should never be assumed, but should be proven by an analysis of comparable sales.

Returning to our example, the real estate agent breaks each of the fifteen sales down by dividing sales price by living area and the resulting unit value range is from \$100 to \$110 per square foot of living area. The narrowing of the range from \$200,000 - \$400,000 sales price to a unit value range of \$100 to \$110 per square foot is substantial and indicates that living area was a prime motivation in price paid for the comparable sales. Thus, application of a unit value of \$100 to \$110 to the subject's living area indicates a price/value conclusion.

This example indicates the strength in comparative unit analysis; however, the strength is in consistency. If the comparable sales analyzed were not measured in a consistent manner with the subject, the strength of this analysis is diminished. For example, if the comparable sales were measured from the outside, and the real estate agent measured the subject from the inside, the subject property would thus be underpriced, and the agent left money on the table. Worse – the agent has potentially opened the door to a liability issue if the market norm is exterior measurement.

Let's take this a step further, and look at consistency between organizations. If the real estate agent measures from the inside and appraisers measure from the outside we have additional inconsistencies created. In the current example, the inconsistency is caught if the sale is contingent upon financing. If the agent obtains a contract based upon interior square footage and the buyer's financial institution obtains an appraisal, with the appraiser measuring based upon exterior measurement, the value would likely be different than the contract price. Again, if the Realtor's method was inconsistent with the "norm", this could open the door to liability issues.

Appraisers often rely upon real estate agent data for comparable data, often measuring only the subject property in their appraisal process. Appraisers are not required by Fannie Mae to measure comparable sales, but instead use sources such as Realtor Board's Multiple Listing Service (MLS). If MLS data is used the appraiser must include the MLS #. An error or inconsistency in agent measurement could also impact the appraisal outcome and again open the door to a liability issue.

Consistency is key!

National Measurement Standard

Some of this inconsistency has been eliminated by the wide acceptance of a common measurement standard created in 1996, a standard that provides consistency between organizations and between geographic areas.

The ANSI standard was created initially in 1996, revised in 2003. It is identified as "Square Footage-Method for Calculating: ANSI Z765-2003". It is a voluntary standard created through a consensus process that involves more than just appraisers and real estate agents or brokers. The standard was developed by the National Association of Home Builders (NAHB) and Research Center with the American National Standards Institute (ANSI). The creation of a measurement standard for residential dwellings is largely the result of a request by the Home Builders Association of Greater New Orleans. It is this organization along with other builder members that commissioned the NAHB Research Center to act as secretariat for an ANSI Accredited Standards Committee to assemble a group of organization representatives and individuals materially and directly affected by the development of an ANSI Standard for the measurement of square footage in houses.

ANSI is a central body responsible for identifying a single, consistent set of voluntary standards and verifying that the principles of openness and due process are heeded. The acceptance of this as the measurement standard is evidenced by the groups that participated in its creation, including NAR, along with other professional, governmental and quasi-governmental agencies.

A partial listing of organizations represented on the initial committee is as follows:

- American Assoc. of Certified Appraisers
- The American Institute of Architects
- The Appraisal Foundation
- BOMA International
- Bureau of the Census
- Employee Relocation
- RS Means (estimator)
- Fannie Mae
- Freddie Mac
- NAHB
- National Association of Realtors (NAR)
- US Department of Energy
- HUD

ANSI Document

NAHB Research Center: www.nahbrc.org

It is recommended that each student obtain a copy of the most current standard.

Benefit of the ANSI Standard: The standard provides a uniform method of measuring and consistent defined terms. Without ANSI, a Realtor's only direction is local practices and local definitions for real estate terms.

The property types covered by ANSI-Z765 include:

- Detached single-family houses
- Attached single-family houses

The ANSI standard does not establish measurement standards for other property types, including condominiums. Condominium measurement will be discussed at the end of this section.

By definition:

- **Detached Single-Family House** – A house that has open space on all its sides.
- **Attached Single-Family House** – A house that has its own roof and foundation, is separated from other houses by dividing walls that extend from roof to foundation, and does not share utility services with adjoining houses; may be known as a townhouse, row house, or duplex, for example.

Terminology:

The next item to understand is ANSI terminology. Because the ANSI standard crosses a variety of professions interested in measuring and labeling the area of single family residential dwellings, along with geographic areas, the terminology is not consistent with that utilized in most multi-listing services, or that utilized often by real estate agents, brokers, and appraisers in Louisiana. The primary difference is in the term "Living Area". Because Living Area is a market derived term, the definition of which varies from Louisiana and various other parts of the nation, the ANSI standard defines the area of the house in terms applicable across the nation and across professional affiliations. Specifically, ANSI divides the area of a house into two identified spaces: **Finished Area** and **Unfinished Area**. In order to understand that ANSI can be used as a standard, we need to understand how it relates to the terminology utilized by real estate agents and brokers.

ANSI TERMS VS. MARKET TERMS

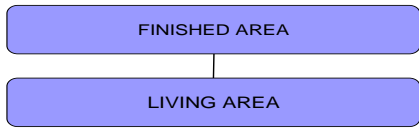

The ANSI defined term Finished Area is considered by many professional organizations and governmental agencies to be consistent with Living Area. The method of area calculation is recognized in professional publications and by various professional boards as the standard for computing and labeling the area of a house.

Per ANSI, **Finished Area** is defined as “an enclosed area in a house that is suitable for year-round use, embodying walls, floors, and ceilings that are similar to the rest of the house”.

The emphasis in ANSI is consistent finishes throughout, meant for “year round” use. The ANSI standard even identifies acceptable finishes. Actually, the initial publication of the 1996 ANSI standard identified floor finishes, specifically excluding bare or painted concrete as acceptable finishes. The 2003 revision clarifies acceptable floor finishes to include “stamped, stained, and acid-etched concrete floors in conditioned space.” The revised document retains that painted and unfinished concrete floors will not be considered in the calculation of finished area.

Unfinished Area is defined as the “sections of the house that do not meet the criteria of finished area.”

ANSI VS. MARKET TERMS

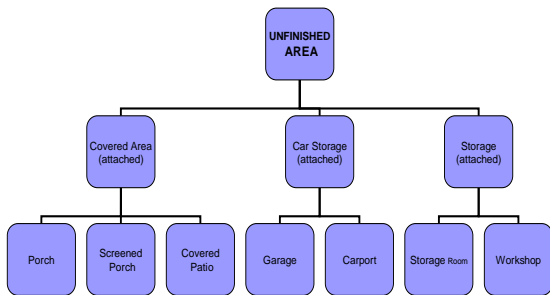

Finishes

The term “finished area” implies finishes are required. In other words, the interior has finished floors, walls, and ceiling. ANSI actually lists acceptable finishes. Per ANSI wall and ceiling finishes include but are not limited to painted gypsum wall board, wallpaper-covered plaster board, and wood paneling. Floor finishes include but are not limited to carpeting, vinyl sheeting, hardwood flooring, and concrete floors with decorative finishes but do not include bare or painted concrete. The issue is “year-round use”, with finishes that are “similar to the rest of the house”. Thus, ANSI indicates that finishes not only need to exist, but the like and quality must not be substandard.

From a practical standpoint, this indicates that an addition to a house with excellent quality finishes should have similar quality finishes. If finishes are obviously substandard, then the “similar” requirement of the finished area definition is violated.

For example, if an addition is constructed on a good quality house with superior quality finishes, (e.g. travertine flooring, sheetrock walls with decorative crown molding, 12’ ceilings, etc.) the addition should consist of similar quality finishes. Thus, a converted garage with vinyl flooring, paneled walls and the garage door left in place would not suffice as “similar” in this example and thus should not be considered finished area. Logically, inclusion of this substandard quality area as finished area/living area would misrepresent the house to fellow Realtors, and likely result in an overpricing of the house. Accurate classification allows for a more accurate comparison of comparable properties. A superior quality house constructed with 3500 SF of finished/living area is not equivalent to a house with 3000 SF of good quality finishes + 500 SF of substandard finishes. A true identification of the house is 3000 SF of finished area plus a “bonus” area of 500 SF. The classification of substandard space in MLS must be adequately explained in the comments to help fellow real estate agents understand the listing.

Contiguous Requirement

The computation of the area of a house (finished and unfinished) is based upon attached areas. Outbuildings such as pool houses, guest houses, storage buildings, etc., that are detached from the house structure are not listed in the summation of finished and unfinished area. This area must be identified separately.

The market norm in Louisiana is to call the area “Total Area Under Roof” meaning the area under a single contiguous finished roof structure with finished ceiling. Most MLS systems allow for inclusion of the outbuildings in the amenity category and/or comment sections. It is in these areas that the size of the outbuildings can be discussed. Detached structures should not sum to the total area under roof figure in order to be consistent with the ANSI standard. Total area under roof is a summation of ANSI defined finished and unfinished area.

From a logical standpoint, if a client is in the market for a house with three bedrooms to service the needs of the young family, the search results of a three bedroom house should not include a two bedroom house with a detached guest house. Misrepresenting such a property would waste the time of clients and agents confused by the misrepresentation. Further, the house will likely be overpriced if the market values a guest house as a lower unit value than the main house. However, if a buyer desires a three bedroom house and a guest house, the guest house should be searched through the amenity or comments category.

Above Grade vs. Below Grade

ANSI defines **Grade** as the ground level at the perimeter of the exterior finished surface of a house.

Per ANSI, a distinction must be made between area above grade and area below grade. Subsequent to this identification, the area is then identified as Finished or Unfinished area.

The above-grade finished square footage of a house is the sum of finished areas on level that are entirely above grade. The below-grade finished square footage of a house is the sum of finished areas on levels that are wholly or partly below grade.

Thus, the ANSI standard indicates that even a split level, where a portion of the floor is below grade, must be identified as finished or unfinished below grade.

ANSI states that no statement of a house's finished square footage can be made without the clear and separate distinction of above-grade areas and below-grade areas.

Level

Per ANSI a level includes areas of the house that are vertically within 2 feet of the same horizontal plane. Per ANSI, finished area square footage is the sum of the area on each level. Some MLS systems only allow a certain number of levels. Any information inconsistent with the ANSI identification should be adequately explained in the comments.

Method of Measurement

- Finished Adjacent to Finished
- Finished Adjacent to Unfinished
- Ceiling Height Requirement
- Stairs
- "Disconnected" Finished Area
- Two Story Measurement
- Measurement Units
- Declarations
- Unfinished Area such as Porches and Balconies
- Garage

ANSI requires that Finished Area is measured **at floor level to the exterior finished surface of the outside walls** for detached structures, from the centerlines for attached structures and to the exterior edge of unfinished surface of any partitioned area when finished adjoins unfinished areas.

Finished Adjacent to Finished

When finished area is adjacent to finished area the common wall is divided equally between the two areas. For instance, a townhouse adjoining another townhouse has a common wall. The measurement requires the common wall thickness to be divided between the two units. The following is a bird's eye view of adjoined townhouse units. The roof is removed and the view demonstrates the perimeter wall thickness, along with a thickness of the common wall. As can be seen, the area calculation is based upon a measurement to the centerline of the common wall.

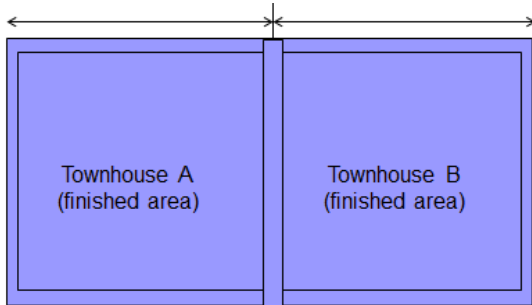

Finished Adjacent to Unfinished

When finished area is adjacent to unfinished area the common wall thickness is computed with the finished area. Examples of this occur in many houses with exterior accessed storage rooms and garages. The following example is a house with a garage. Measurement of finished area extends to the inside surface of the garage. A physical method of pulling the tape is to attach the measuring tape to the exterior corner of the garage and pull to the interior wall finish of the garage in width and depth. By subtracting the garage computed area from the total area computation, the finished area is obtained.

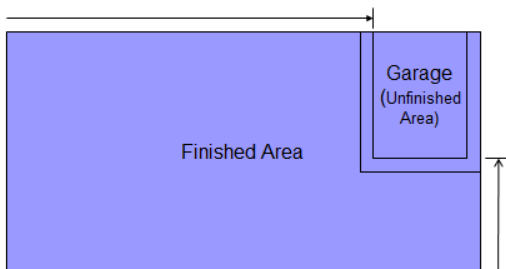

For a partition that separates a finished area from an unfinished area, with no finished walls on the unfinished side, the measurement of finished area extends to the partition closest to the unfinished area – usually a wood stud or other framing member. An example of this is a second story finished area with a door leading to unfinished storage. The measurement of finished area extends to the stud of the common wall closest to unfinished area.

Ceiling Height Requirement

Per ANSI ceiling height must be considered when computing area.

- Finished Areas must have a ceiling height of **at least 7 feet**, except under beams, ducts, and other obstructions where the height may be 6'4". The area under stairs has no ceiling height requirement
- If the ceiling slopes, ½ of ceiling height must be at least 7 feet
- **No** portion of the finished area that has a height of **less than 5 feet** may be included in finished square footage

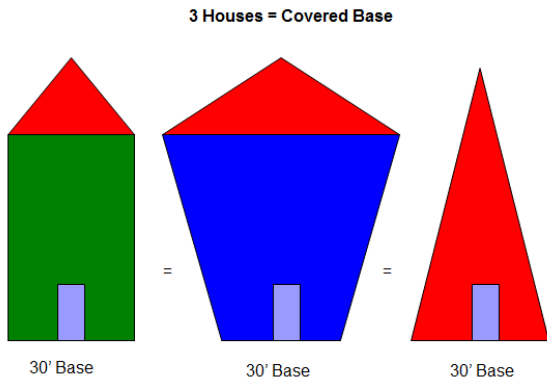

Without the ANSI ceiling height requirement, if these three houses had covered bases that measured 30' X 30' from the exterior, then their area calculation would be the same.

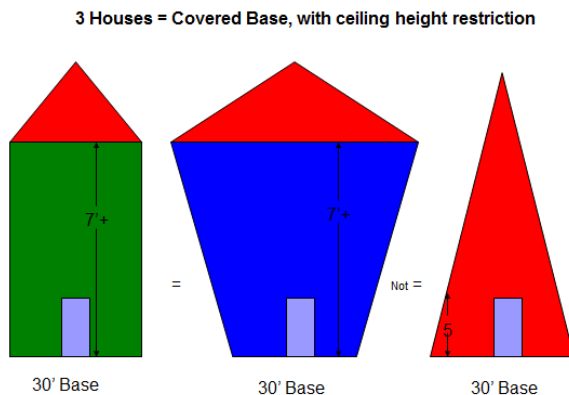

Consideration of the ANSI Measurement requirements indicates that the "A" frame house is not equal due to the sloping ceiling caused by the roof line. Thus, the "A-framed" house is limited in finished area. The finished area consists only of the floor area where the ceiling height is at least five feet. This vertical measurement is an interior measurement, and the length multiplied by the width of the floor area is an interior measurement. ANSI indicates that where finished areas are adjacent to unfinished areas, the finished square footage is calculated by measuring to the exterior edge or unfinished surface of any interior partition between the areas. Because no partition exists, the standard indicates that no benefit is given for an exterior wall. Thus, the interior dimension is used. Market practices are sometimes inconsistent in this interpretation and include an exterior wall thickness adjustment to the length of the interior dimension to equate the dimensions to an exterior dimension.

The example here is actually a situation very prevalent in the Louisiana market area. Often the second story/level of a house is constructed in the roof lines, producing the “A-framed” area. The market typically refers to such a house as an Acadian style house. The ceiling height limitations caused by the roof line must be considered to provide an ANSI compliant area calculation.

Stairs

Per ANSI, stair treads are included as “walkable” area of the ascending story, provided that the opening in the floor does not exceed the area of the stair treads. Further, the treads can only be included if a floor does not already exist. As noted previously, the area under stairs has no minimum ceiling height requirement. Thus, one would not deduct for a less than 5’ ceiling height if it is the stairs causing the ceiling height restriction. Often the area under stairs is finished with a ½ bath or closet. Even though the ceiling height infringes on the 5’ vertical height, the area is still part of the finished area. Again, the area under stairs is not deducted from the base level because of ceiling height.

ANSI acknowledges that it is a common practice to provide a floor opening for stairs that is the same size as the stairs themselves. Therefore, the area of stairs included in finished square footage is typically equal to the area of the opening in the floor.

The following example is a “perfect two story”, or a second story that directly sits on top of the first story, with the treads filling the entire floor opening. This is a bird’s eye view, with the stairwell displayed in white and the actual floored area in blue. The computation of area is based upon exterior dimensions: length multiplied by width multiplied by two (2) to compute sum finished area on each level. Obviously a portion of the treads do not fill the stairwell or opening. This portion of the treads exceeding the stairwell is not included in the second floor calculation, only that portion that fills the well.

Stairs fill the entire “well”

They are included in 2nd floor finished area

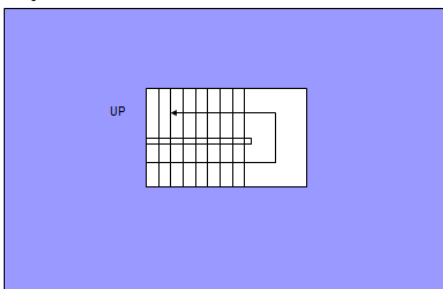

AREA COMPUTATION: Length X Width X 2

The next example contains open floor area to the floor below. The stairs do not completely fill the stairwell. In this bird’s eye view, the stairwell is white. It is evident that the treads do not completely fill the well. The open area must be subtracted from the second level area computation.

Stairs DO NOT fill the entire well

Only portion with treads is included in 2nd floor finished area

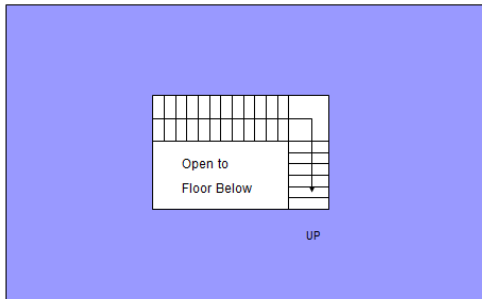

AREA COMPUTATION: (Perimeter Length X Width X 2) – (Length X Width of floor opening)

Fireplaces, Bay Windows and other Protrusions

In order to be considered part of the finished and unfinished area of a level, the area must have a floor on the same level. Thus, a bay window must have a base at that level to be included, and the ceiling height must meet the ceiling height restrictions. A house with a protruding window that does not come up from the base is not included in the area calculation, regardless of ceiling height.

A fireplace that extends beyond the exterior finished surface of walls is not included in the finished area. A fireplace that is situated in a corner of the house is included in the living area, as long as it does not protrude from the exterior wall. If the hearth is located within the exterior finished surface of the house on the first level and the chimney extends through the interior of the second level without a hearth on the second level, no deduction is made from the finished square footage of the second level. This may not be consistent with local practices, but is the ANSI standard.

“Disconnected” Finished Area

In order to be included in the finished square footage at any level, the finished area must be connected to the main body of the house from other finished areas. Connections include rooms, hallways or stairways. This indicates that a finished area under roof that is accessed through a garage, carport or breezeway is not to be included in the finished square footage calculation for that level. This area does equate to total area under roof, however, is not finished area/living area for the level. Again, inclusion of such a space implies “year-round use” area “similar to the rest of the house.” ANSI indicates this to NOT be the case. Thus, an office accessed from a storage room, a bonus/media room accessed through the garage, or an apartment accessed through a breezeway, is not contiguous in access and should not be included in the finished area summation for that level.

The MLS identification of area does not often adequately describe this type of area. Thus, if not adequately identified in the MLS classification of space, the real estate agent/broker should describe the disjointed finished area in the comments. In many cases, the only applicable category may be storage, with an explanation in the comments that “so many” square feet of storage is actually finished area used as an office. This area is not included in the finished area/living area calculation. Appraisers have more flexibility with identification of this area. It is often presented as a line item description/adjustment, with the identification of the area being “bonus” area.

Two Story Measurement

ANSI does not define the method of two story measurement, only indicates that finished area must be consistent with the finished area definition, meet the ceiling height and base requirements and must be accessed from other finished areas. As a practical application, this means that interior dimensions are often relied upon, with conversion to exterior dimensions for consistency with ANSI. Measurement technique and understanding the method of adjusting interior dimensions to exterior dimensions will be discussed in the Residential Measurement and Area Calculation Procedure section.

Measurement Units

ANSI states that when using English measurement units, the house is measured to the nearest inch or tenth of a foot. To be efficient in measurement and mathematical calculation, the market norm is to measure using a tape measure calibrated in tenths. This means that some rounding to the closest inch or tenth is allowed in the linear dimensions. This too will be discussed in the Residential Measurement and Area Calculation Procedure section.

The final reported finished square footage of a house is to be reported to the nearest whole square foot. Thus, rounding to the nearest square foot is also allowed.

Know that the ANSI standard makes no statement concerning differences between square footage calculations made by multiple parties for the same property. The impact of rounding to the nearest inch or tenth in the linear dimension and then rounding to the nearest whole foot in the square area calculation does, however, lend itself to the possibility of slightly different area calculation between parties. The material impact of these “rounding” differences should be immaterial if the proper measurement methods are followed.

Declarations

The ANSI standard does include several declarations to clarify when reporting area. These are required when compliance with the actual measurement and inspection of the property is not performed. These declarations “must” be included to adequately explain the level of inspection and measurement.

Declaration 1 must be made when the interior of the structure was not inspected. ANSI provides sample verbiage as follows: “Finished square footage calculations for this house were made based on measured dimensions only and may include unfinished area, opening in floor not associated with stairs, or openings in floors exceeding the area of the associated stairs.” This caveat allows a user of the information to understand the limitations of the finished area calculation, however, should only be applied when the interior could not be viewed. For example, a repossessed house without allowed access to the interior. Application of this declaration by a real estate agent should be an exception to the normal course of listing a house.

Declaration 2 must be made when the area is based upon plans. ANSI provides sample verbiage as follows: “Finished square footage calculations for this house were made based on plan dimensions only and may vary from the finished square footage of the house as built.” This declaration should only be used for proposed construction. An existing structure should be measured and area calculations computed/confirmed. Use of this declaration by a real estate agent should not be applied in the normal course of listing an existing house.

Declaration 3 must be made when area calculation is based upon estimated dimensions. ANSI provides sample verbiage as follows: “Finished square footage calculations for this house were made based on estimated dimensions only and may include unfinished areas, or openings in floors not associated with stairs, or openings in floors exceeding the area of associated stairs.” This caveat should only be used when direct measurement of the structure is not possible. For instance, an adversarial case such as a repossessed property where a real estate agent/broker may be required to market a property with an occupant that refuses access. ANSI also describes such a case when physical access to the structure is not possible due to the nature of the terrain or other obstacles that may preclude direct physical measurement of the exterior in the time available.

Unfinished Area such as Porches, Balconies, and Decks

These areas are not considered suitable for year-round occupancy, thus cannot be included in the Finished Square Footage. The listing of these area calculations must be separate. ANSI states the measurement of such areas is also based upon a linear measure of the exterior finished surface of the house to the outer edge of the floor surface area or exterior surfaces. The square area is calculated similar to the finished area method.

Garage

Because the ANSI measurement standard is a uniform standard that addresses construction types in various geographic areas, some of the local standards must be considered. ANSI addresses this in the treatment of the area of a garage. ANSI acknowledges that garages can never be included in finished square footage area; however, the method of including the area in unfinished square footage differs in different market areas. The distinction is based upon the location of the garage: under the house or adjacent to the house. ANSI states that when the garage is located beneath the main body of the house, some localities treat the area as the unfinished area of the house; however, when the garage is attached to the house it is often identified separately as a garage and not included in the unfinished area of the house summation. Our market standard in Louisiana will be addressed in the Measurement Procedure section of this presentation. However, know that in Louisiana, the typical custom is to include a garage as part of the unfinished area, if attached to the house, and include the summation of this area with finished area to determine the total area under roof.

Relating ANSI Terminology to MLS Terminology

There are currently thirteen local Member Boards in the State of Louisiana covering 45 parishes throughout the state that are part of the Louisiana REAL ESTATE AGENT OR BROKERS Association, including:

- Realtors Association of Acadiana
- Baton Rouge
- Bayou - Houma
- Central Louisiana
- Greater Fort Polk
- Livingston
- Natchitoches

- New Orleans Metropolitan
- Northeast
- Northshore
- Northwest
- Saints
- Southwest

The various Boards subscribe to different multiple listing services. These services, however, utilize similar terminology when identifying the area of a house. Most provide a summation of area identified as Total Area Under Roof or Total Square Feet. This area is a summation of Living Area, and other areas such as storage, car storage (garage or carport) and porches. The standard requirement for inclusion in each of these categories is that the area be contiguous with the main structure. Thus, detached buildings such as storage sheds, guest houses, pool houses, etc. are not included in the total area under roof summation. The classification of such detached areas is typically done in the amenity category and the area discussed in the comment section.

TOTAL AREA UNDER ROOF

- Living Area
- Storage
- Porch / Patio
- Car Storage (Carport and/or Garage)

The following terms and definitions are based upon market practices. Each is then related to ANSI.

Total Area Under Roof: Contiguous area of the house that has finished roof over a solid base. The requirement is that the roof is contiguous and finished to the like and quality of the rest of the house. Further, the roof must have finished ceiling. Thus, an awning without finished ceiling would not be classified as part of total area under roof. Further, soffit is not considered finished ceiling. The base must be a solid base, not gravel. Total Area Under Roof (TAUR) is a summation of the subcategories that meet at a minimum, the contiguous base and roof requirement. Consistency with ANSI would indicate that TAUR is the summation of both finished and unfinished area on each level.

Living Area: A sample market definition used by a Louisiana Board states “Living Area is our market term used to describe the finished, heated and cooled habitable contiguous area of a house measured from exterior walls.” This definition is consistent with ANSI’s requirement for exterior measurement. Further, the definition indicates the area must be contiguous and have finishes. To be consistent with ANSI, the finishes must not be those specifically excluded, such as painted concrete, must be similar to the rest of the house, and must provide for year-round use. The market definition indicates a requirement for heating and cooling in order to be considered living area. ANSI, however, does not address ventilation. If heating and cooling is considered a finish, then the consistency of finishes throughout should apply. Thus, if a house is constructed with central air and heat, then an addition with a window unit is substandard. Inclusion of the substandard area appears to violate the “similar” requirement. Understand that different Boards may have varying requirements; however, it is obvious that consistent like and quality is key.

Also noted, is that the market definition does not indicate a mandatory ceiling height requirement. The ANSI standard, however, is very clear. Per ANSI ceiling height must be considered when computing area.

- Finished Areas must have a ceiling height of **at least 7 feet**, except under beams, ducts, and other obstructions where the height may be 6'4". The area under stairs has no ceiling height requirement
- If the ceiling slopes, ½ of ceiling height must be at least 7 feet
- **No** portion of the finished area that has a height of **less than 5 feet** may be included in finished square footage

Thus, ceiling height must be considered in the market definitions to remain consistent with ANSI.

Storage: By definition a storage room is a room in which things are stored. As far as inclusion in Total Area Under Roof, the storage must be attached or contiguous with the main house. Storage rooms vary in their level of finish. The common thread to classify an area as storage is inferior quality of finish and/or no direct access from living area.

It is mandatory that living area flow from living area. Thus, an area that is not accessed from living area should not be included in the living area/finished area category. Without another description, this type of space is typically placed in storage. Of concern is when the area is superior in quality to what a user would classify as storage, however, is not directly accessed from living area. Examples would include a garage apartment accessed through the garage, a game room accessed from the exterior only but under the contiguous roof with the house, a home office accessed through a carport or garage, etc. Many MLS systems do not provide for a term to classify this non-contiguous area under the main roof, but agree that it cannot be considered Living Area due to access.

Computation of this area is necessary because it represents a component part of total area under roof. A common practice is to include this area in the storage classification. If this is done, the real estate agent/broker should adequately describe the classification of space in the comments section. Valuation, of course, is not dependent upon classification. Placement of an area in the storage classification does not indicate minimal value. The valuation of any unique space should be based upon market derived data, not simply a value based upon terminology.

Porch / Patio: A porch is an open or enclosed gallery or room attached to the outside of a building/house. In order to be included in Total Area Under Roof, the porch/patio must be attached, have a base and be covered by primary roof structure. In Louisiana a patio is often the term used to define a rear porch area. Some MLS systems include the classification of "covered patio", yet others do not. If such a category is included, classification of space requires base and primary roof. For MLS systems without the sub-classification "covered patio", the rear porch area would be included in the porch classification. ANSI states that porches, balconies, decks, and similar areas that are not enclosed or not suitable for year-round occupancy cannot be included in the Statement of Finished Square Footage but may be listed separately, measured from the exterior finished surface of the house to the outer edge of the floor surface area or exterior surface. It is clear that such space is considered unfinished space and can be included in the summation if it is contiguous and meets the Total Area Under Roof requirements.

Garage/Carport: Area constructed for storage of automobiles or other vehicles. In order to be included in Total Area Under Roof, this area must have a base and be covered by primary roof structure. The total area under roof requirement is contiguous, thus a detached garage/carport is not to be included in the Total Area Under Roof Requirement. Should the norm in a particular area consist of houses with detached garages, constructed to the like and quality of the house, this should be evident in the discussion of space, however, Total Area Under Roof requires contiguous area. Again, this is to provide a consistency in the description of space. The valuation of such space is based upon market data.

ANSI identifies Unfinished Area as “Sections of a house that do not meet the criteria of finished area.” Thus, storage, car storage, porches, etc., that are attached to the house and do not meet the finished area requirements, should be identified as “Unfinished Area”. ANSI states that measurement is “from the exterior finished surface of the house to the outer edge of the floor surface area or exterior surface, and calculated by using the method referenced in the standard.”

RESIDENTIAL MEASUREMENT AND AREA CALCULATION PROCEDURES

The purpose of this section is to teach a method of measuring and calculating the square footage of detached and attached single-family house that is consistent with the ANSI National Standards and further defined by standards in Louisiana market areas.

American National Standards Institute (ANSI) outlines house measuring in “Square Footage-Method for Calculating: Z765”, published by NAHB Research Center, 400 Prince George’s Boulevard, Upper Malboro, Maryland 20774-8731 – Phone (800) 63808556 / <http://www.nahbrc.org>. It is recommended that each student obtain a copy of this document.

Steps to Compute Area

There are chronological steps to follow when computing area of a house.

- Measure the Structure
- Convert any Interior Dimensions to Exterior Dimensions
- Mathematically Square the Structure
- Compute Area of Each Component Area: Living Area, Storage, Porches, Car Storage
 - Divide Structure into Geometric Figures
 - Label, then Compute the Area of each Figure
 - Sum each component Area
- Sum the component areas to derive Total Area Under Roof

Tools Needed

Tools Needed for Measuring Structures

Tape measure, typically 100 feet in length, with a hook on the “dumb” end. Either metal or fiberglass is acceptable. A metal tape may cut hands, and might break if stepped upon. A fiberglass tape is utilized most often, however, needs to be replaced periodically due to stretching over time. A measuring wheel is not accurate to the degree required for residential measurement. A laser is limited in use for exterior measurement. House plans is a useful tool, however, if the house exists verification of dimensions and finished area is required unless circumstances exist where actual measurement is not possible. In those instances, an appropriate ANSI declaration must be provided indicating any limitation in reliance on area. Prior appraisal sketch is a useful tool, however, dimensions and area calculation must be verified for accuracy as of the effective date of your listing. Should the agent contract with a qualified individual to measure and provide area calculation, this should be supported with a written document.



The tape measure should be calibrated in feet and tenths of feet, **not** feet and inches. **An inch is not equal to a tenth of a foot!** (If you must use a foot/inch tape, you convert the inches to tenths by dividing the inches by 12. For example, 6 inches is equal to $6/12$, or 0.5 feet)

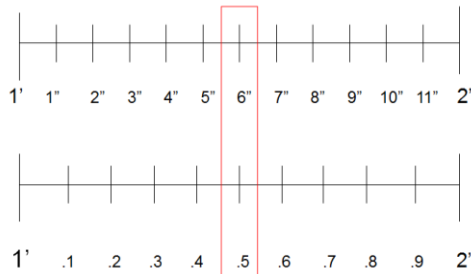

Viewing a tape measure with each foot calibrated in tenths, each tenth is further divided into ten equal segments identified as hundredths. This represents the second place value after the decimal point. ANSI requires measurement of each distance to the nearest tenth of a foot, or the first place value after the decimal point. Thus, rounding to the nearest tenth is allowed. When the distance is exactly between two tenths, it is recommended that the distance is recorded to the hundredth place value to allow for easier mathematical squaring. This will be addressed in the area calculation section. With this said, the only number that should be recorded in the hundredth place value is a five (5). This indicates that the distance was exactly between two tenths. In all other cases, the distance should be reported as feet and tenths of a foot.



Legal-size clip board or the equivalent

Legal-size or letter-size graph paper calibrated 10 squares per inch is essential to **accurately** draw a structure. Graph paper enables you to draw to scale and 10X10 graph paper increases your speed and accuracy of counting. One (1) square equates to one (1) foot, thus bold line to bold line equates to ten (10) feet. Utilizing 10X10 graph paper, a 54' wall does not require you to count 54 squares, but instead 5 blocks of 10 squares and (4) four small squares.

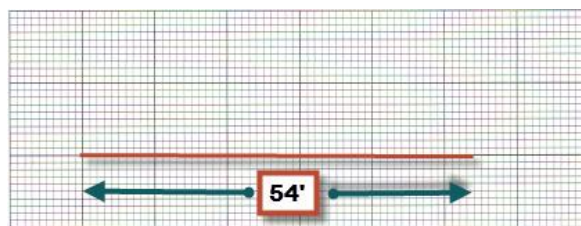

Pencil with a good eraser (a spare pencil is always a good idea)

Comfortable clothes (shrubs can be very difficult on fragile clothing). Additionally, a pair of rubber boots is a must in Louisiana!

A **laser** may be used to assist in a perimeter “wall to wall” dimension, when an accurate reading can be obtained. Consistency with the standard tape measure must be verified prior to any reliance on same.

Basic Measurement Procedures for a House

Per ANSI, a detached single family house is a house that has open space on all its sides.

The goal of measuring is to measure square footage of the **Total Area Under Roof**. To comply, the area must have a base and be covered by the primary roof structure. Calculation of square footage is measured by using **exterior** dimensions. Each dimension is measured to its nearest tenth of a foot.

Measuring the house:

Before measuring the first wall, walk around the exterior perimeter of the house to get familiar with the shape of the house and to look for potential hazards. A review of the shape of the house relative to the street allows you to determine the method to hold your clipboard. A house elongated parallel to the street would require you to hold your clipboard horizontal. A house that is elongated perpendicular to the street would require you to hold your clipboard vertical. You want the house to fit on the graph paper without adjustment. There are several hazards that are difficult to notice when measuring, so a walk-around is key. Typical hazards when measuring include wasps, ants, and animals. It is best to become aware of hazards when doing your “walk around” than to encounter same when measuring. Many hazards can be avoided, as long as you are aware of them. Additionally, a walk-around allows you to view the shape of the house, exterior finishes, condition, along with viewing any evident structural issues – e.g. exterior cracks

Choose a corner of the house as your starting point, your “point of beginning”, and begin your drawing in the corresponding corner of your graph. Positioning your drawing this way will allow maximum drawing space on the paper. When you draw, the clipboard remains in the same position, reflecting that actual situation of the house on its base. Your stomach should always face the wall you are drawing, moving around the clipboard as to rotate around the house. Again, the clipboard does not move, you move. The best method of measuring is to work your way around the house counter clockwise, or pull the tape left to right. When this is done the tape is upright and easier to read.

Physically, the hook should be placed on a corner, with the easiest place being about chest high. This should change if a protrusion (i.e. shutter) can be avoided. In such a case, you may need to adjust the hook higher or lower. Once hooked, it is easiest if the reel is held in the right hand and the left hand slides along the tape to the end of the wall. Along the wall, the tape should be parallel with the ground, pulled tight enough to relieve sagging, but not too tight to stretch the tape. Push the end of the tape to the edge of the measured wall and read the tape. Remember, you are allowed to round to the nearest tenth of a foot. Thus, a dimension that pulls to 6.48’ should be written as 6.5’.

The house will be drawn on 10X10 graph paper. Each square on the graph paper is equal to one foot. Additional tenths are drawn into the next square as accurately as possible. For example, if the dimension is 27.5', you would count 27 squares and one half of a square to place your end point. Walls of the house are drawn with solid lines, while covered areas (porches, carports, etc.) are drawn with dotted or dashed lines. Walled areas include living area, storage and garage, thus each area drawn must be labeled to ensure accurate calculation.

Hook the end of the tape at the corner and measure the wall. Before drawing the line, use the grid lines to write the dimension. Place the dimension on the graph paper to fall outside of the wall, centered when measuring on the outside. The dimension should always reflect where it was pulled. There will be occasions where a dimension will be taken from the interior (e.g. second level of a 1.5 story house). In these instances, pulled dimensions will be recorded where pulled, or in the inside. Such dimensions must be adjusted to exterior dimensions in order to comply with ANSI. This will be discussed in a later section of this class.

Once the dimension is written, count the appropriate number of squares, place your endpoint and connect to form a line (solid for walls, dashed for covered areas). Continue around the exterior of the house in this manner until you reach the original starting point. The house will be drawn to scale, and any errors in measuring or drawing will become obvious.

Your drawing should reflect the areas that comprise Total Area Under Roof – Living Area (solid line), Storage (solid line), Porch (dashed line), Carport (dashed line), Garage (solid line). Be sure to accurately label the component areas of the house.

If the drawing does not close, check the dimensions of the drawing and verify that the drawing equals the written dimensions. If it does not, then you must spot check dimensions while you are at the site. This is the reason that the 10X10 graph paper is used. It provides evidence of problems while you are at the site and saves you from making an additional trip! Another walk around is sometimes necessary for structures with many offsets and insets. All offsets must be measured and the recorded distance equating to the nearest tenth, excluding door jams and widow jams that extend up from the base. These set-in areas are treated as if flush with the wall. A precise measurement reduces measurement adjustment in the squaring process.

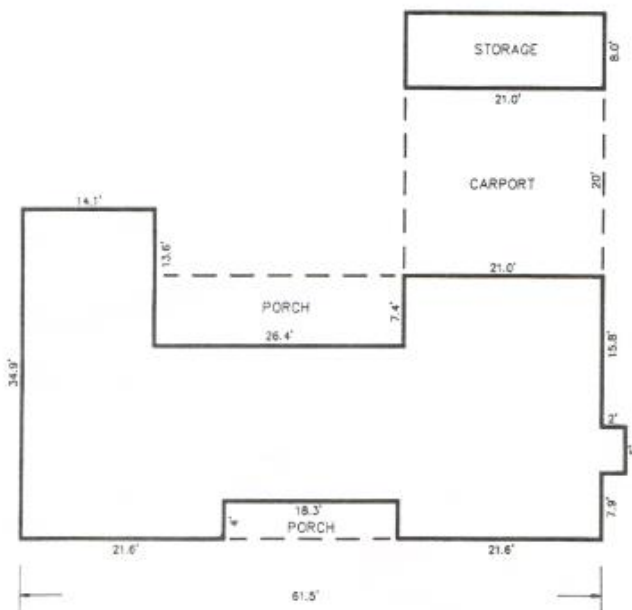

Squaring the Structure, Mathematically

Mathematical computation of area requires that the figure is a closed figure. It is mathematically impossible to compute the area of an open figure, whether it is open by several feet, or by a tenth of a foot. To minimize variances, it is important that there is no gap in measuring. Particular attention needs to be paid to the location of the clip when exterior wall finishes differ. Even with all precautions taken, it is still reasonable for the field drawing to not mathematically square.

When measuring a house, ANSI allows each linear dimension to be reported to the nearest tenth. Thus, linear dimensions are often rounded slightly up or down. It is reasonable due to this rounding, for the structure to be slightly off when mathematically closing the structure. Should this occur, adjustment is necessary to create a mathematically closed structure prior to computing area. Again, any adjustment from the field drawing to the adjusted closed structure should be slight and only due to rounding of dimensions to the nearest tenth. Any large disparity indicates a measuring error and would require verification by revisiting the site.

The rule of a rectangle requires that the parallel lengths are exactly equal, and the parallel widths are exactly equal. If this is proven true, the length multiplied by width equates to square area, or feet X feet = SF. It is this rule that we use to verify if a structure is square. In other words, the method involves encompassing the entire structure into a rectangle and verifying that the opposing sides are exactly equal.

STEPS FOR SQUARING THE STRUCTURE

1. Set up four columns: Front Side (FS), Back Side (BS), Left Side (LS), Right Side (RS)
2. Tally the dimension in the appropriate column along the designated side
3. Front should equal Back, if not adjustment(s) must be applied
4. Left side should equal Right side, if not adjustment(s) must be applied

GOAL: Prove the structure to be mathematically squared, or FS = BS and LS = RS

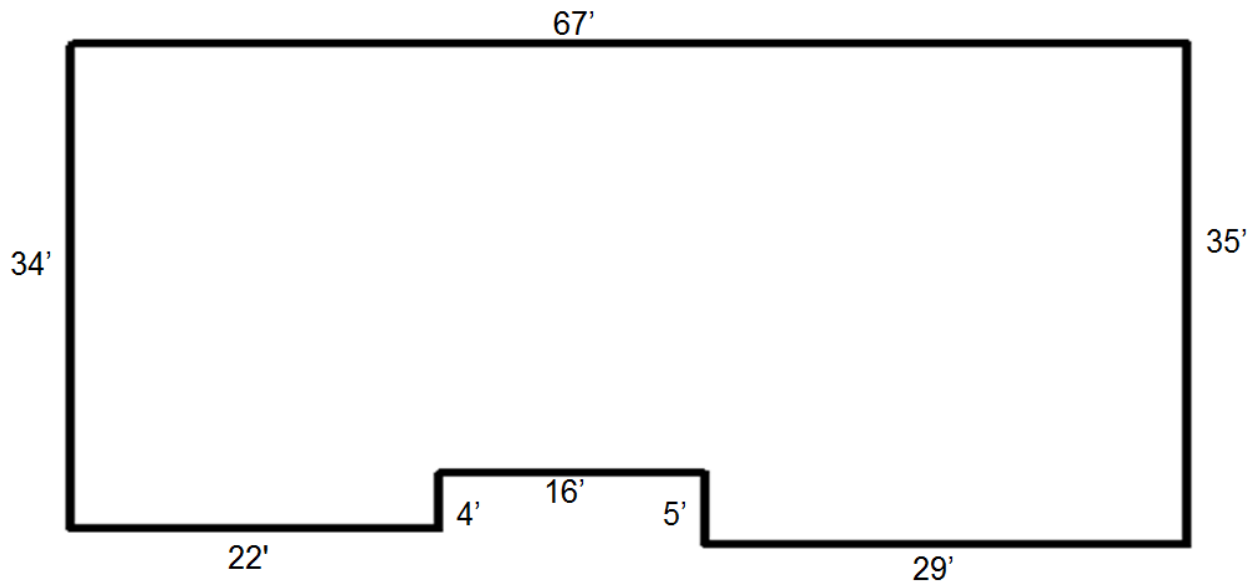

To begin: Establish your four columns; FS, BS, LS, RS

Front Side (Left to Right)	Back Side (Left to Right)	Left Side (front to back)	Right Side (front to back)
-------------------------------	------------------------------	------------------------------	-------------------------------

GOAL:

Front Side (Left to Right)	=	Back Side (Left to Right)		Left Side (front to back)	=	Right Side (front to back)
-------------------------------	---	------------------------------	--	------------------------------	---	-------------------------------

TALLY DIMENSIONS:

Front Side (Left to Right)	=	Back Side (Left to Right)	Left Side (front to back)	=	Right Side (front to back)
22		67	34		35
16			-4		
29			5		
67.00	=	67.00	35.00	=	35.00

RESULT: The property is proven to be mathematically square, area calculation can begin.

LIVING AREA

	Length	X	Width	=	SF
A	34	X	22	=	748
B	30	X	16	=	480
C	35	X	29	=	<u>1015</u>
			L.A.	is	2243

Changed Example – linear dimensions to not “square up”!

Now let's assume that when you pulled the dimensions, the structure did not mathematically square. Your field drawing indicated the following dimensions:

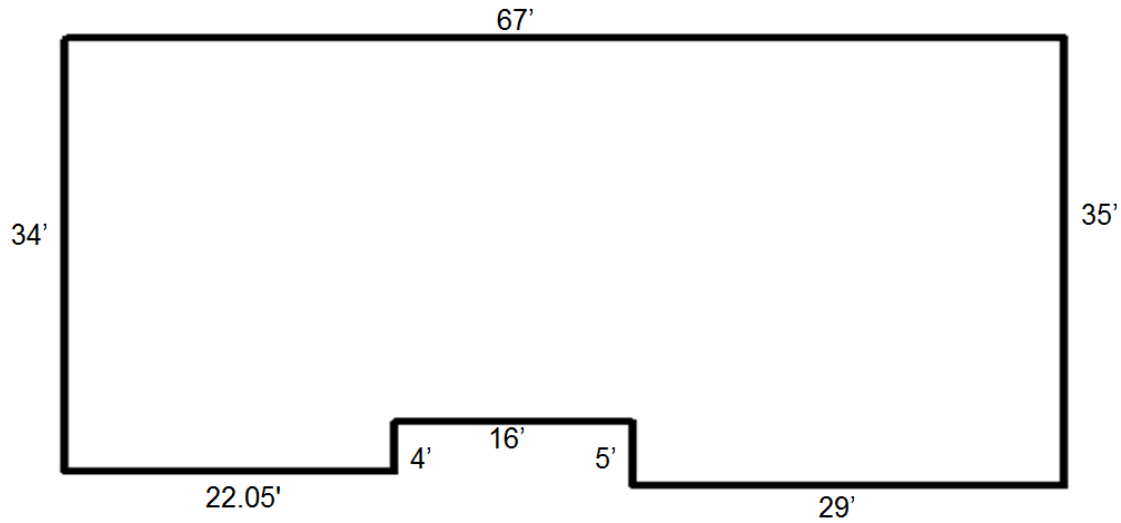

To begin: Establish your four columns; FS, BS, LS, RS

Tally the dimensions:

Front Side		Back Side	Left Side		Right Side
(Left to Right)		(Left to Right)	(front to back)		(front to back)
22.05		67	34		35
16			-4		
29			5		
67.05	Not =	67.00	35.00	=	35.00

Left Side = Right Side

Front Side Does NOT EQUAL Back Side

RESULT: Must adjust prior to area calculation in order to create a squared structure.

Choice:

- Add 0.05 to a dimension along the back, or
- Deduct 0.05 from a dimension along the front

Either choice is an option; however, different choices will result in slightly different area calculations. Let's look at two different choices.

Adding 0.05 to the rear, or back side length:

Front Side		Back Side	Left Side		Right Side
(Left to Right)		(Left to Right)	(front to back)		(front to back)
22.05		67.05	34		35
16			-4		
29			5		
67.05	Now =	67.05	35.00	=	35.00

Structure is now squared and area calculation is as follows:

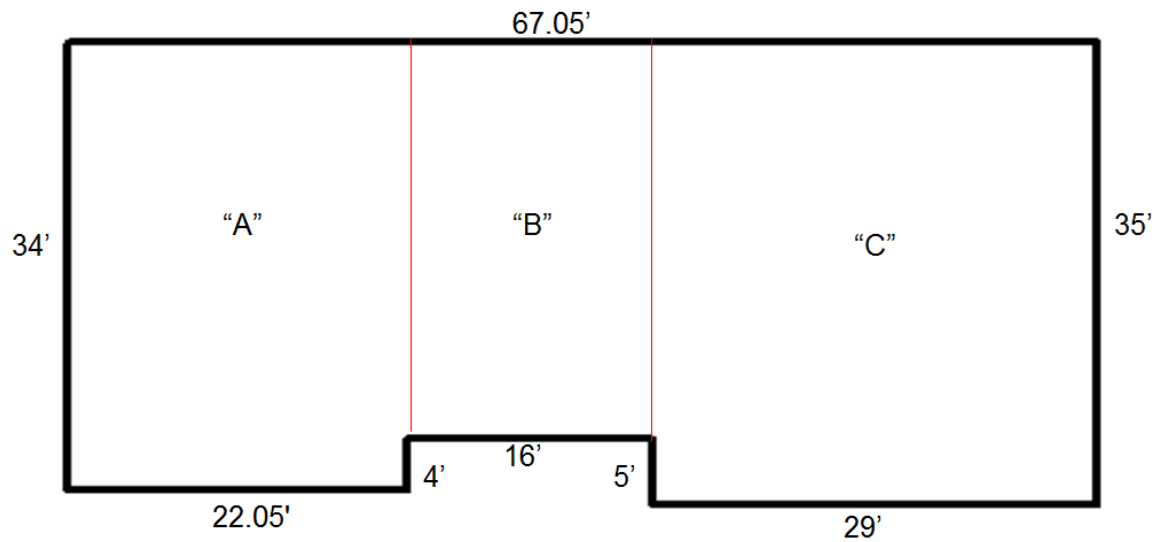

LIVING AREA

	Length	X	Width	=	SF
A	34	X	22.05	=	749.7
B	30	X	16	=	480
C	35	X	29	=	1015
					2244.7
			L.A.	is	2245

Alternative Adjustment:

Deduct 0.05 from a dimension along the front, keeping the rear 67' dimension intact

Front Side		Back Side	Left Side		Right Side
(Left to Right)		(Left to Right)	(front to back)		(front to back)
22.0		67.0	34		35
16			-4		
29			5		
67.00	Now =	67.00	35.00	=	35.00

Structure is now squared and area calculation is as follows:

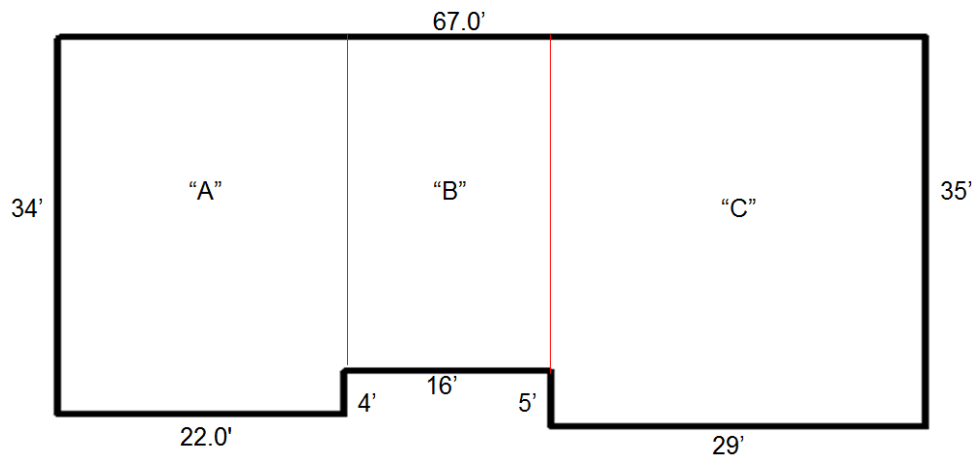

LIVING AREA

	Length	X	Width	=	SF
A	34	X	22	=	748
B	30	X	16	=	480
C	35	X	29	=	1015
			L.A.	is	2243

The impact on area calculation using either choice is minimal, but the area summation is slightly different, or in this example 2245 SF vs. 2243 SF. This adjustment is allowed due to rounding!

Even real estate agents and appraisers that use drawing programs must mathematically ensure the structure is squared prior to putting the dimensions into a drawing program. A drawing program does not solve such an issue.

Calculate the Square Footage

Computing Total Area Under Roof

For multi-listing purposes, the goal is to compute total area under roof. The area of each component (living area, storage, porch, car storage) is individually computed and then totaled to reach the square footage of the house, under the contiguous roof. The area of each geometric figure is calculated using basic formulas, and added together to arrive at a total area for each component. Most houses will be comprised of simple rectangles the area of which is computed by multiplying length by width.

Even a complicated looking structure can be typically subdivided into rectangles. For example:

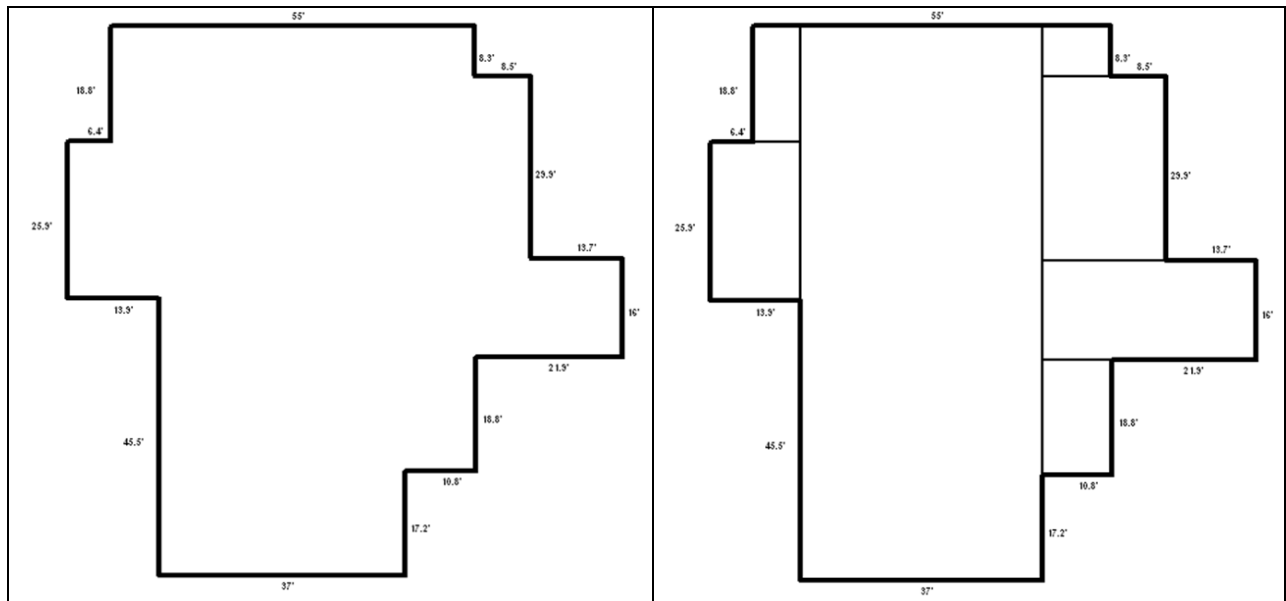

When using a tape measure calibrated in tenths, multiplication without conversion results in area. If using a tape measure calibrated in inches, any inch dimensions must be converted into tenths prior to multiplying the length by the width to get area.

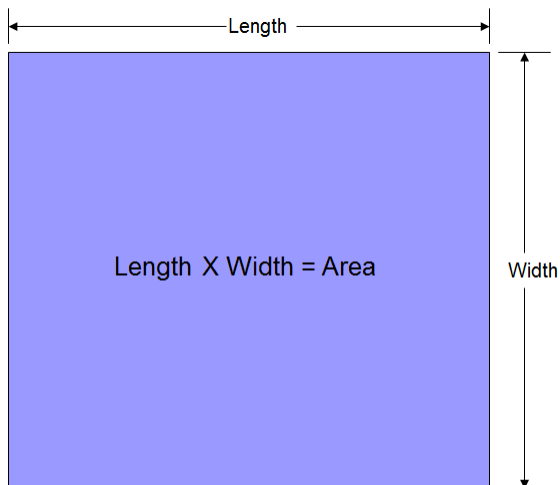

Conversion Example:

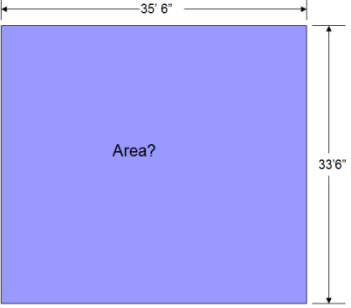
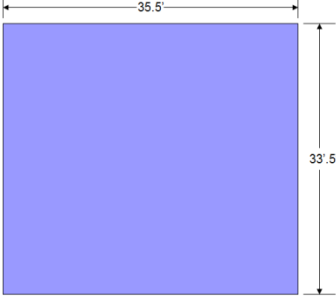
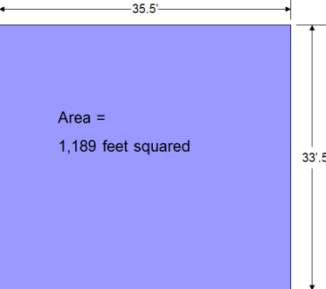
 <p>Area?</p> <p><i>inches must be converted into tenths</i></p>	<p>$6''/12'' = 0.5$</p> <p><u>Measurement</u> <u>Conversion</u></p> <p>$35'6'' = 35.5'$</p> <p>$33'6'' = 33.5'$</p>	 <p><i>Feet X Feet = Square Feet</i></p>
 <p>Area = 1,189 feet squared</p>	<p>$L \times W = SF$</p> <p>$35.5' \times 33.5' = 1,189.25 SF$</p> <p><i>1,189 SF, rounded</i></p>	

Relating Living Area (User Defined) to Finished Area (ANSI Defined)

Living Area is our market term used to describe the finished, heated and cooled habitable contiguous area of a house measured from exterior walls. As was previously presented, there is now a national standard for defining and computing the square footage of a single family residence. This national standard is “Square Footage – Method for Calculating: ANSI Z765”. With this standard, the market term Living Area definition is encompassed and expanded in the “finished” defined area of ANSI. A difference, however, is that the square footage defined by ANSI does not address air conditioning and ventilation. Our market standard states living area must be heated and cooled in a consistent manner.

The ANSI standard defines space as either “finished” or “unfinished”. Per ANSI, the term *finished* is “An enclosed area in a house that is suitable for year-round use, embodying walls, floors, and ceilings that are similar to the rest of the house.” ANSI states that Square Footage is measured using exterior dimensions. Further, for a room to be included in the square footage calculations the floor located under sloping ceilings must have a clearance of at least 5 feet; and, at least one-half of the square footage in the room must have ceilings with a minimum of 7 feet. Note that the area of both stair treads and landing(s) proceeding to the floor below is included in the finished area of the floor from which the stairs descend, not to exceed the area of the opening in the floor. In order to be included in the finished area category, all areas must be connected to the house by continuous finished areas such as hallways or staircases. (Note: if a finished area is adjacent to an unfinished area, you measure to the exterior edge of the partition between the areas).

Living Area/Finished Area is typically the primary focus in residential measurement. Accuracy is important when there is a proven relationship between price and the size of the house. This accuracy enables the agent to properly determine most probable price, and will also ensure accuracy when used by future real estate agents and appraisers to establish a sales price/square foot or list price/square foot relationship. Thus, accuracy impacts your deal and future deals.

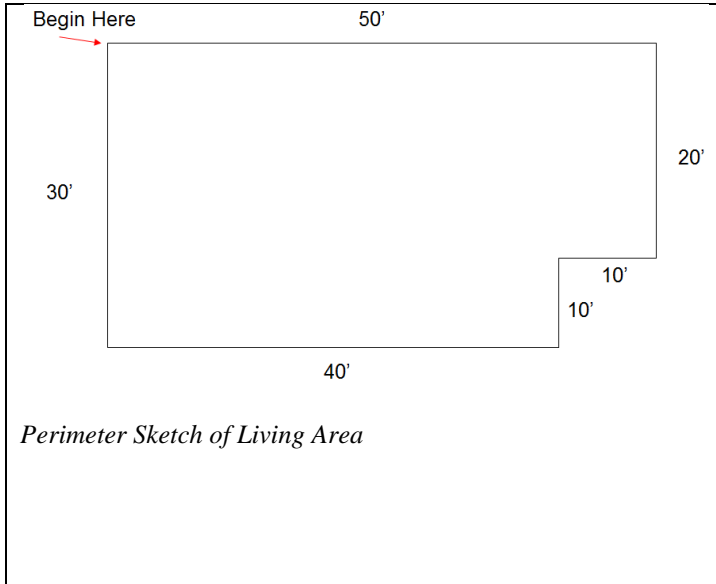

- STEPS**
1. Divide Structure into Geometric Figures (dimensions are exterior because they are written on the exterior). Figures can differ based upon your view.
 2. Label Each Figure in a chronological order (e.g. A, B, C...)
 3. Compute the Area of Each Figure
 4. Sum it up

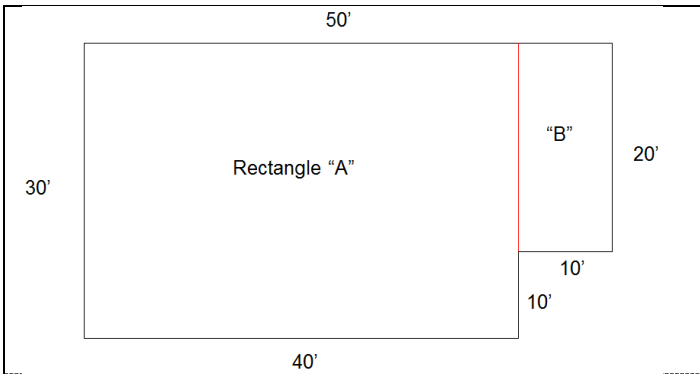

COMPUTE AREA

Length	X	Width	=	Area (SF)
■ A) 40'	X	30'	=	1200 SF
■ B) 20'	X	10'	=	200 SF
■ Total Living/Finished Area =				1400 SF (or 1400 feet squared)

-or-

-or-

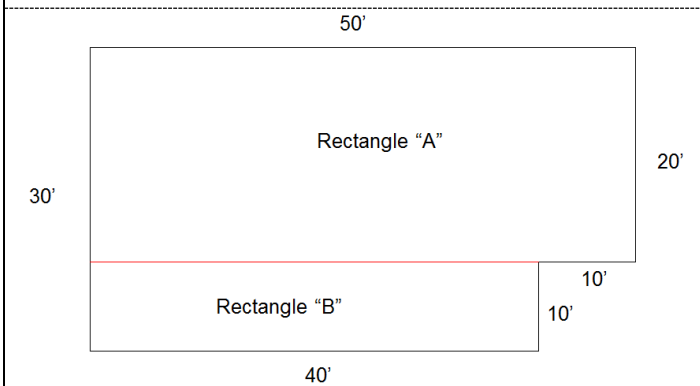

COMPUTE AREA

Length	X	Width	=	Area (SF)
■ A) 50'	X	20'	=	1000 SF
■ B) 40'	X	10'	=	400 SF
■ Total Living/Finished Area =				1400 SF (or 1400 feet squared)

Other divisions of space are possible too. Correct division and calculation results in the same area conclusion if performed accurately.

Storage, Porches, Car Storage

Next, “other areas” under the roof of the house are calculated and included. Only that area which is covered by the main roof of the house is to be included in Total Area Under Roof. Any additional areas, e.g. detached pool houses, detached guest houses, detached gazebos, etc., are computed and identified in the amenity category and/or noted in “Remarks” section of MLS.

Per ANSI, Unfinished Area is simply “Sections of a house that do not meet the criteria of finished area.” The other areas in total area under roof would be considered “unfinished area” per ANSI Standards.

Often, finished areas are adjacent to unfinished areas. Per ANSI “the finished square footage is calculated by measuring to the exterior edge or unfinished surface of any interior partition between the areas”. Examples of this occur in many houses with exterior accessed storage rooms and garages under the primary roof. The following example is a house with a garage. Measurement of finished area extends to the inside surface of the garage. A physical method of pulling the tape is to attach the measuring tape to the exterior corner of the garage and pull to the interior wall finish of the garage in width and depth. By subtracting the garage computed area from the total area computation, the finished area or living area is obtained. Remember, the dimension must be taken from the exterior, or adjusted to reflect an exterior dimension.

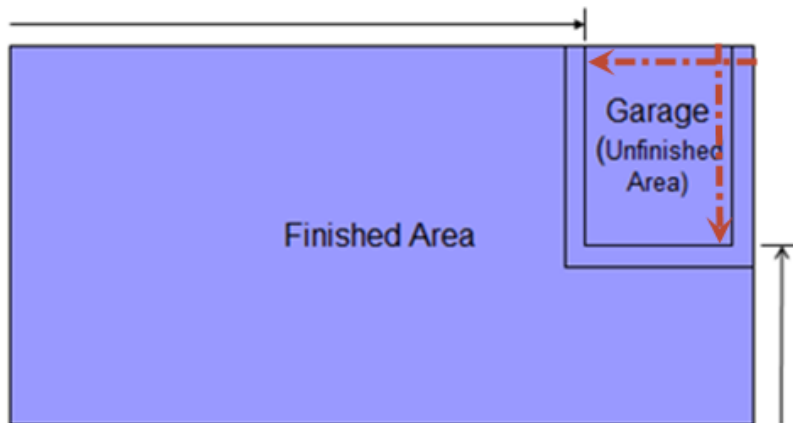

Special Features in a Single Family House

Remember, all areas must have a base at the reported level and meet the ANSI ceiling height requirements (the average ceiling height in a room must be at least 7 feet and sloping ceilings must have a clearance of at least 5 feet).

1. Bay Windows:

A bay window is usually a small area that protrudes from the main house. It is typically found in the kitchen or breakfast area, but is also common in dining rooms and bedrooms. A bay window differs from a window seat or window box in that it has a foundation. That area with a foundation will be included in the living area of the house at the level of the base. Window seats or window boxes are not to be included in living area.

A bay window is often comprised of an area with angled perimeter walls. The following is a view of a perimeter sketch of a house with a bay window.

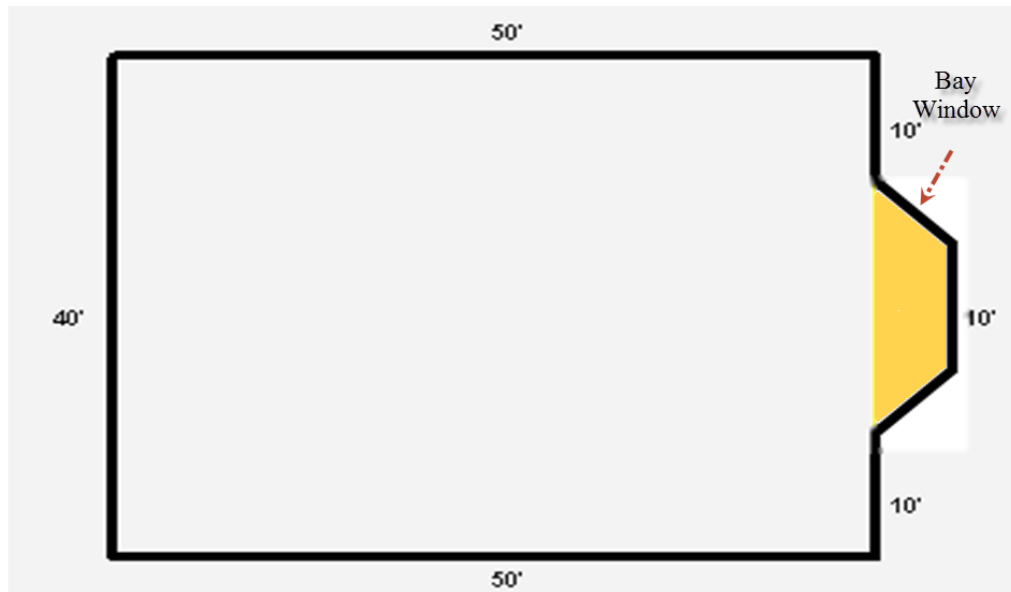

A bay window actually consists of three geometric figures: one rectangle and two triangles.



The area of the rectangle is length multiplied by width. The formula to compute the area of a triangle is:

$$\underline{\text{Base} \times \text{Height}}$$



Problem: Base and Height are inside and do not actually have walls!

ANSI requires that finished area calculations are based upon exterior dimensions. The problem is that the base and height of the triangle on an angled wall lies within the inside of the house. Additionally, there is usually not a wall forming the base and the height. Because the triangles are right angled triangles, the “base X height” formula can be simplified by stating that the area of the triangle is half of the area of the rectangle. It is this logic that enables a simplified measurement of the triangle from the outside.

BAY WINDOW

Measure Mirror Image – Outside!

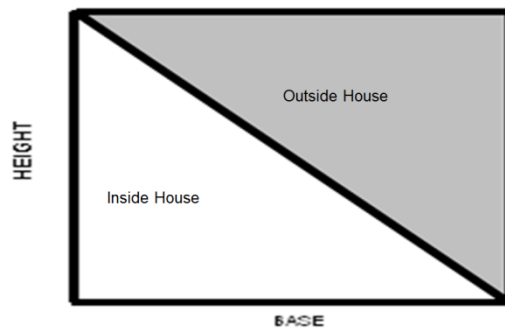

BAY WINDOW

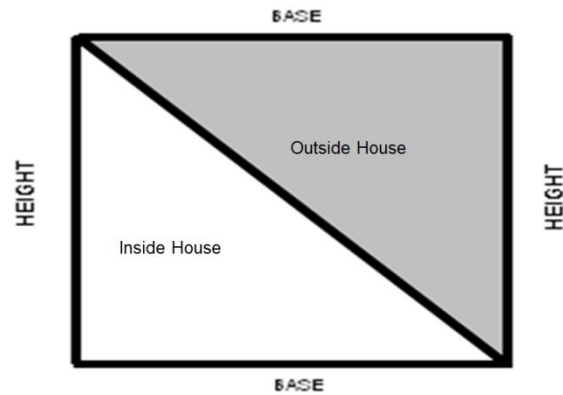

This solves the problem of converting interior dimensions to exterior dimensions. There remains the issue of no true wall forming the outside edge (base and height) of the triangle. It is thus useful to have a straight edge used to provide an extension of the wall. A useful straight edge is a retractable tape measure or a yard stick. In either case, the tool is not used for measurement, but instead to provide a measurement guideline. Additionally, squaring the structure often provides a check for either the base or height of the triangle.

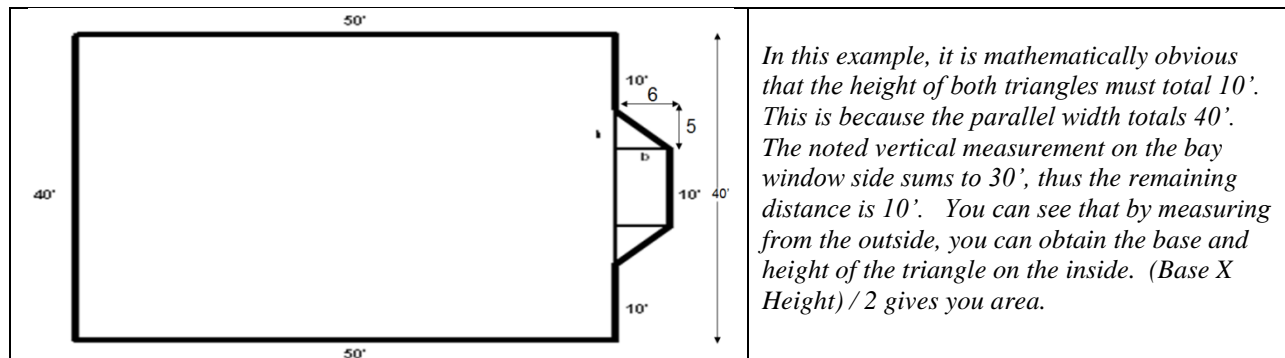

Question:

Compute the area of the house noted above:

Note: Remember to divide into geometric figures and label each figure

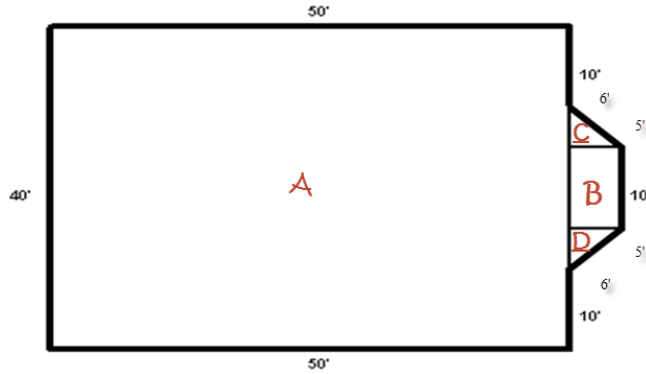

LIVING AREA					
	Length	X	Width	=	SF
A	50	X	40	=	2000
B	10	X	6	=	60
C	(6	X	5)	/ 2	= 15
D	(6	X	5)	/ 2	= 15
			L.A.	is	2090

Answer: 2,090 SF

This same principle applies when measuring other sections of a house that may contain triangles instead of rectangles. The important thing to remember when measuring the house with an angled wall, measure the dimensions that will enable you to calculate the square footage. The diagonal of the triangle is not used in the area calculation.

Multi-Level House – 2 story

A perfect two story house is a situation where the second level directly sits on top of the first level. In this scenario, assuming there is flooring on both floors and the ceiling height requirement is met, the area calculation can be obtained from the outside. If it is a perfect two story, the calculation is the first level area calculation multiplied by two (2).

This is an example of a perfect two story, where the stairs completely fill the stairwell and the second story sits directly on top of the first level.

AREA COMPUTATION: Length X Width X 2

Remember, if the stairwell is not entirely filled with the treads, the open area must be deducted from the receiving floor calculation.

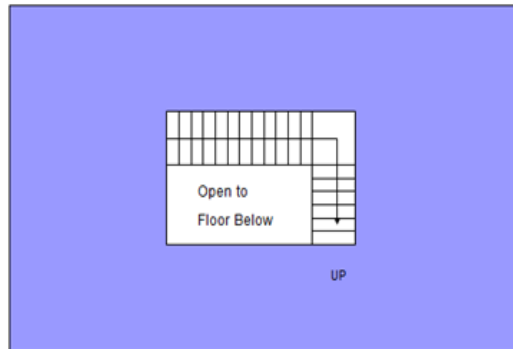

AREA COMPUTATION: (Perimeter Length X Width X 2) – (Length X Width of floor opening)

This is an example of a two story, where the stairs DO NOT completely fill the stairwell. The open area must be deducted from the second floor calculation.

Typically, a two story house is not a perfect two-story, but dimensions can still be obtained from the outside. Often the second level will sit like an “L” or a “T” on top of the first level. The drawing method is to measure and draw the first level. Beneath the first level on the graph paper draw the second level, obtaining all possible dimensions from the outside. Sometimes, it is necessary to obtain some dimensions from the inside. In such an instance, the dimensions must be written on the inside to indicate the location of the pulled measurement. Inside dimensions require conversion to exterior dimensions prior to computing area in order to comply with the ANSI area calculation requirement.

Because a single line represents a wall, it is visually difficult to see the necessity of converting interior dimensions to exterior dimensions. Note however, if you draw an interior wall when you measure on the interior, visually the adjustment becomes obvious. You can see from the following example why an inside dimension does not always equate to an exterior dimension. The method of drawing an interior wall makes this visually evident.

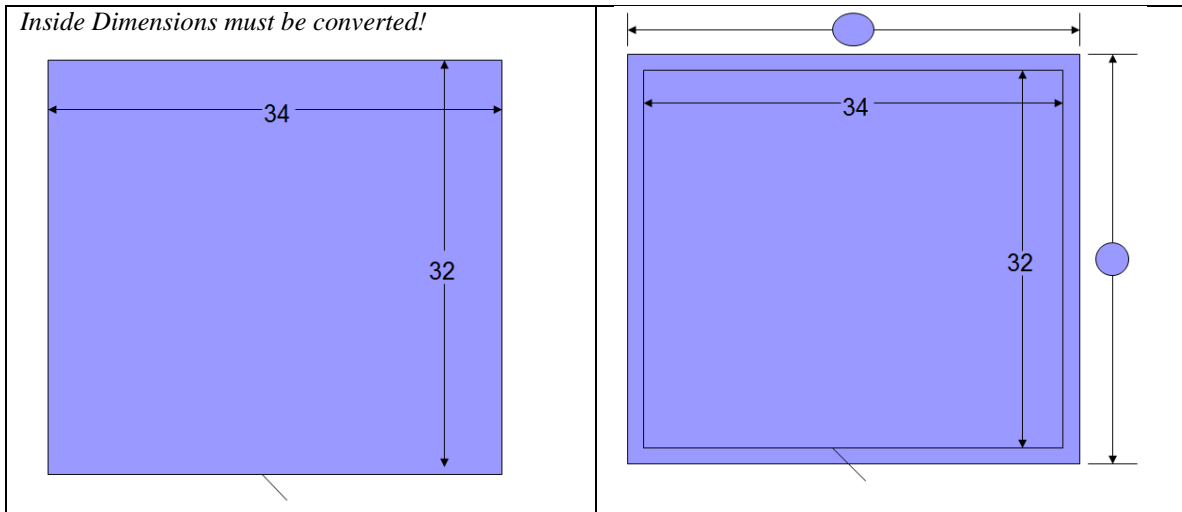

Interior to exterior wall thickness adjustment is not the same for all houses. It is based upon a summation of the exterior wall, studs, and interior wall thicknesses. It is possible to determine the appropriate adjustment on each subject house by measuring a cut through, or an exterior door jam or window jam. You measure from the exterior to the interior of the cut through – molding on top of the perimeter wall should not be used in the adjustment.

Let's continue the prior example and open the door. The measurement sums to 0.8 per wall in this example, or a perimeter wall thickness slightly less than a foot. With the adjustment factor determined, it is now possible to convert the interior dimensions to exterior dimensions. As is evident in the prior drawing, the interior length could be converted to an exterior length by adding two wall thicknesses. The interior width could be converted to an exterior width by adding two wall thicknesses. Remember in the steps to compute area, the interior dimensions must be converted to exterior dimensions prior to squaring the structure and computing area.

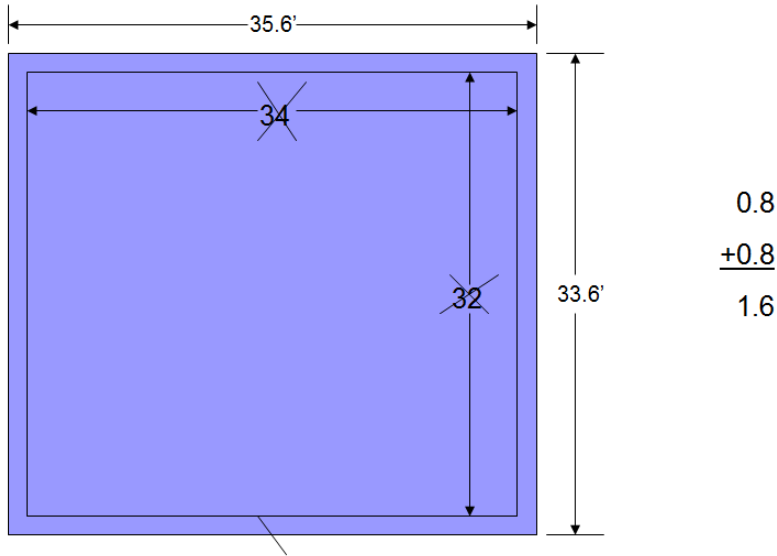

Adjustment factor = 0.8/wall

COMPUTE AREA

■	<u>Length</u>	X	<u>Width</u>	=	Area (SF)
■	1A) 35.6'	X	33.6'	=	1196 SF
■ Total Living/Finished Area					= 1196 SF

The adjustment of interior to exterior dimensions is simplified in the example above. What is omitted in this example is the method of obtaining the inside dimension of a perimeter wall. In truth, it is rare that such a dimension can be obtained with a single pull of the tape. The difficulty of interior measurement is to accurately obtain and sum the various segmented measurements necessary to reflect the full run of the perimeter wall from the inside. It is only when the full perimeter wall distance is concluded that the adjustment process begins. Look again at the simple rectangular house above and understand the number of segments necessary to obtain the full perimeter wall distance on the interior.

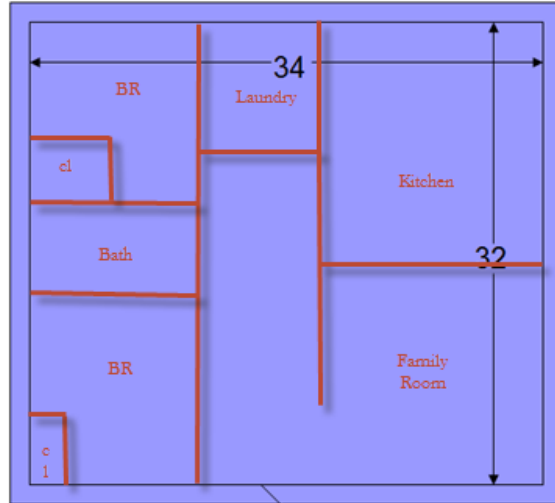

To obtain the 34' interior dimension, let's review the method from left to right. Beginning in the bedroom, the agent must measure interior wall to interior wall, add the thickness of the interior wall between the BR and Laundry, measure interior wall to interior wall of the laundry room, add the thickness of the interior wall between the Laundry and Kitchen, measure the interior wall to interior wall of the kitchen. It is the summation of these segmented dimensions that results in the full interior distance of 34', the interior dimension along a perimeter wall.

The next issue is "where do I hook my tape?" The success of interior measurement requires the agent to open every door, understand the interior layout and determine the most efficient method of determining the perimeter wall distance. It is useful to have two agents working together when measuring, particularly when interior measurement is needed. This enables the agent to have another agent hold the clip at the wall and derive a reliable room size measurement, or interior wall to interior wall measurement. It is not wise to use the assistance of someone unqualified, such as the home owner. Practice makes perfect. Repetition perfects one's ability to understand the layout of a house and determine the most efficient measurements to take. Know that we must all be aware of our limitations. Should the house present a complex design that you are not comfortable with measuring, engage a more qualified professional (fellow Realtor, appraiser, etc.) to perform the measurement and area calculation. Engagement should be done with a written document to protect your liability; acknowledgement of the source of information should be disclosed in your file information.

Remember, use of building plans and/or a prior appraisal floor plan does not protect your liability. Cloning a prior listing does not protect your liability. Measurement is a must to ensure the computed area reflects the actual structure as of the date of your listing.

Question: "Why can't I rely upon previously computed house calculations?"

Addition/alteration – The house may have been changed; an addition constructed, an area demolished, or other alteration that causes the prior measurement to not reflect current area. Your measurement needs to reflect the area of the house at the time of your contract.

Building Plans – The house size, layout and level of finish may have changed during construction. Thus, the plans do not reflect the actual constructed finished area of the house. This often occurs during construction, and new plans are not drawn, the working set is just amended on site. The actual size may be larger or smaller, only measurement of the completed structure reveals same. Again, your measurement needs to reflect the area of the house at the time of your contract.

Prior Appraisal – If the appraisal was not ordered by you, you are not part of the appraiser’s agreement or contract. Further, the conditions of the appraisal may be such that the appraiser applied special conditions about area in the appraisal process, and the floor plan does not reflect the actual are of the house. For example, the appraiser may have been asked to assume the garage was converted into a recreation room. The area calculation is based upon this assumption. At the time of your listing, this change never occurred. Thus, the appraiser’s drawing does not reflect the actual area breakdown of the house.

Prior Listing – The prior real estate agent/broker may have used an unreliable source for the area stated in a prior listing, or inaccurately measured the house. The agent may not be aware of the ANSI standards and may have used interior dimensions. Cloning a listing perpetuates such an error, and affects the use of the sale as a reliable comparable. Not to mention, you may likely lose money by asking below-market value for the house.

Answer: *Protect your own liability by measuring, or contracting a reliable professional to measure for you. The area calculation must reflect the area house as of the effective date of the listing.*

Let’s try an “L” shaped second story example. In this example, the first story is a basic rectangle, with the L-shaped second story sitting on the first story. It is evident that some of the second story dimensions were obtained from interior linear measurement, because the dimensions are written on the interior.

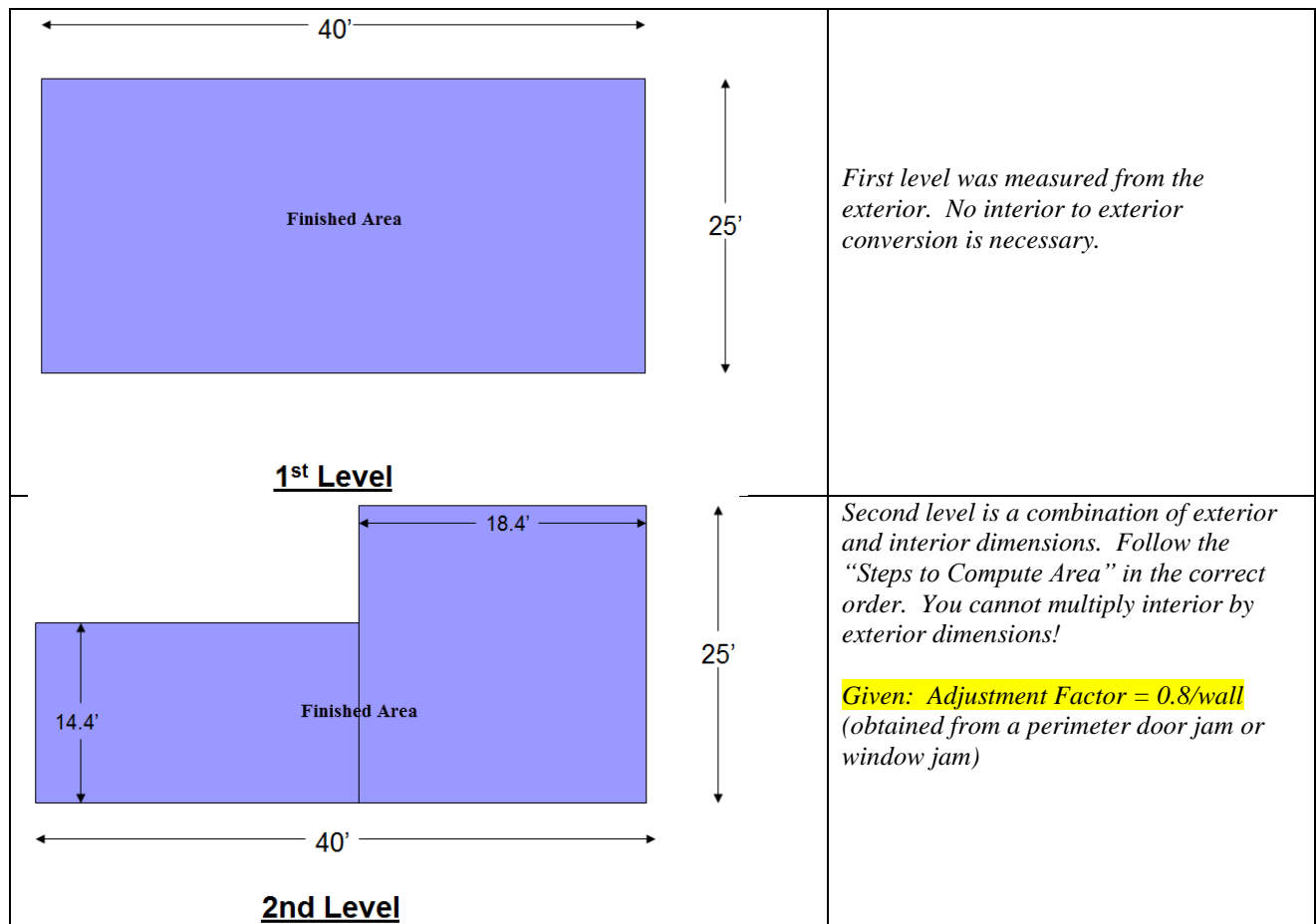

Remember the steps to compute area:

There are chronological steps to follow when computing the area of a house.

- Measure the Structure – *given in this example*
- Convert any Interior Dimensions to Exterior Dimensions – *this must be performed on the second level interior dimension. The first level consists of all exterior dimensions.*
- Mathematically Square the Structure – *in this example that means to complete any missing measurements by utilizing dimensions given*
- Compute Area of Each Component Area utilizing exterior dimensions: Living Area, Storage, Porches, Car Storage – *in this example we only have living area/finished area*
 - Divide Structure into Geometric Figures – *in a multi-level structure, the figures should represent each level. The shape of this house results in a single 1st level rectangle and two second level rectangles in our demonstration.*
 - Label, then Compute the Area of each Figure – *For example use “1A”, 1B”, “1C” to label the geometric figures, on the first level and “2A”, 2B”, “2C” on the second level. In this example the 1st level consists of a single rectangle that could be labeled “1A”. The second level consists of two rectangles. These could be labeled “2A” and “2B”.*
 - Sum each component Area – *this should be done per level*
- Sum the component areas to derive Total Area Under Roof – *in this example, total area under roof reflects living area only and is a summation of 1st level and 2nd level finished areas.*

Again, it must be understood that the physical measurement of the second story involved a summation of segmented measurement. The following is a view of the second level with interior walls and stairs present. For example, to obtain the 18.4' interior dimension, the agent had to measure interior wall to interior wall of the closet, add the closet-bedroom dividing wall, then interior wall to interior wall of the bedroom.

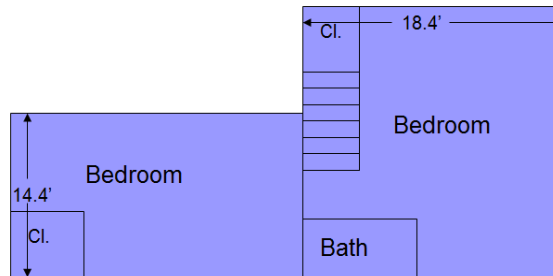

In order to visualize the second level interior to exterior relationship, the following figure includes an interior wall.

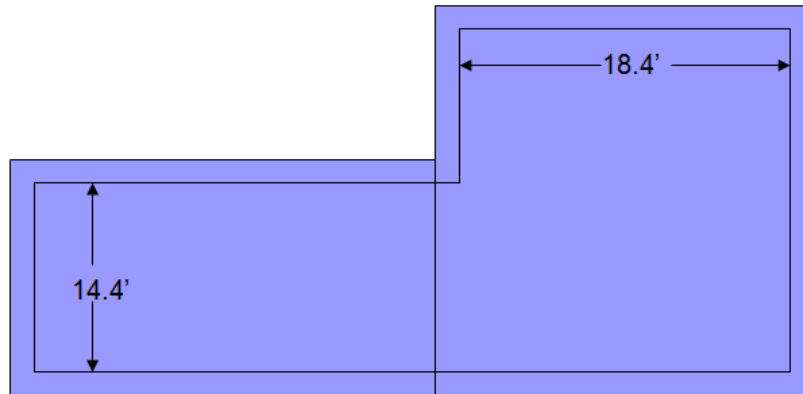

The wall thickness adjustment must be obtained. In this instance, the window jam was measured. The resulting perimeter wall thickness computed to 0.8'/wall for this house. This is the adjustment factor that will be utilized to adjust interior dimensions to exterior dimensions. Step 2 requires an adjustment of interior dimensions to exterior dimensions. It is evident from the drawing above that there are two distances that must be converted, 14.4' and 18.4'. The 14.4' measurement is a vertical measurement that extends from interior wall to interior wall. The figure above makes it visually evident that two wall thicknesses must be added to the 14.4' to equate it to an exterior corner to exterior corner dimension. Similarly, the horizontal 18.4' dimension is shy of two perimeter wall thicknesses. Thus, it too must be adjusted by 0.8' for each wall to equate it to the equivalent exterior wall dimension. The mathematical adjustment is as follows:

$$\text{Wall thickness adjustment} = 0.8'/\text{wall} - 2 \text{ wall thicknesses}$$

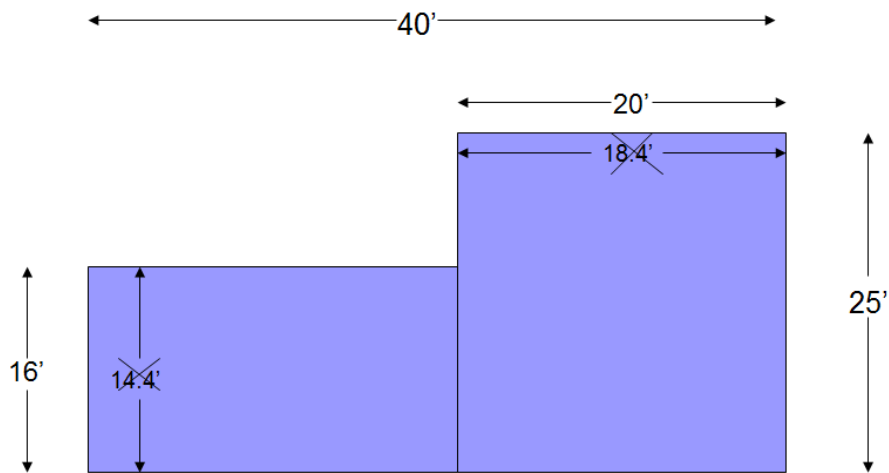

2nd Level

The next step is to mathematically square the structure. In this example, that would entail completing the perimeter dimensions of the walls not yet identified.

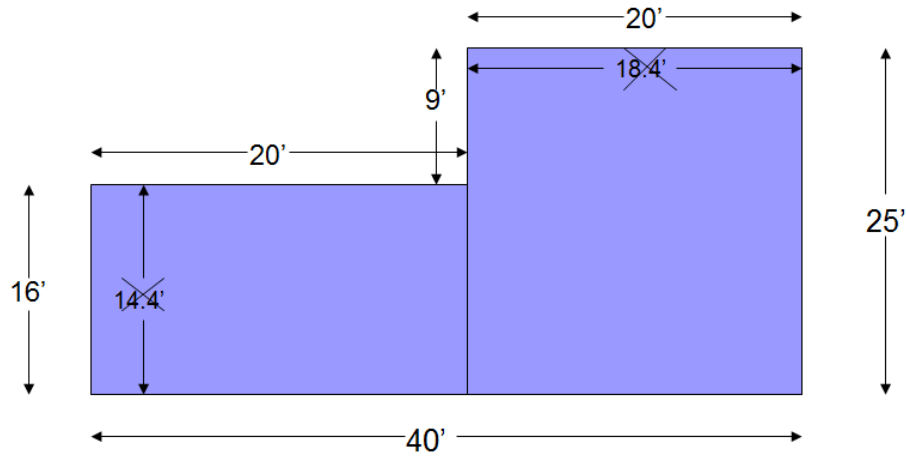

With all perimeter dimensions now computed, it is time to divide the structure into geometric figures and compute area. The following is the method used to identify and label the geometric figures in this example. Know that the figures can be divided in a variety of way, and all result in the same conclusion.

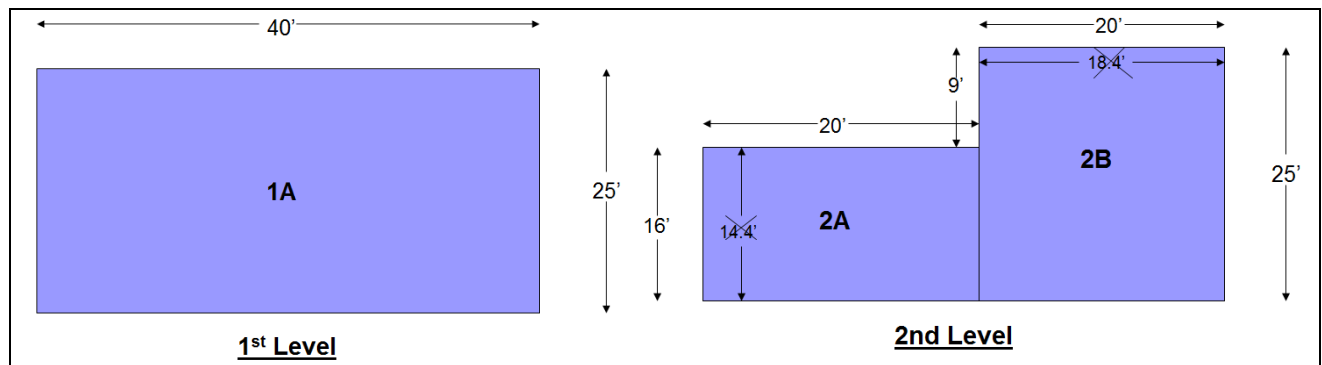

When computing manually (absent a drawing program), it is important to stay organized. The best method is to place the labeled rectangles into a grid. The top of the grid reflects the area formula and the side of the grid reflects the labeled rectangles. The area of this 2 story house can be computed as follows:

COMPUTE AREA

■	Length	X	Width	=	Area (SF)	
■	1A) 40'	X	25'	=	1000 SF	
■	2A) 20'	X	16'	=	320 SF	
■	2B) 25'	X	20'	=	500 SF	
■	Total Living/Finished Area				=	1820 SF

Multi-Level House: One and One-half (1 ½) Story

In this type of house design, the second story is constructed in the roof line. In Louisiana we typically call this an “Acadian” styled house. This is a popular style and you will likely encounter measurement of this type of house early in your real estate career. Remember the ANSI ceiling height requirement. It is in this type of style that often the ceiling slopes below the required level per the ANSI standard. To reiterate, the average ceiling height in a room must be at least 7 feet, and sloping ceilings must have a clearance of at least 5 feet based upon a vertical interior measurement.



The following is a perimeter wall sketch of an Acadian styled house. You can see from the sketch, the second floor sits in the center of the first floor. Thus, exterior inspection does not provide any indication of the second level perimeter wall dimensions.

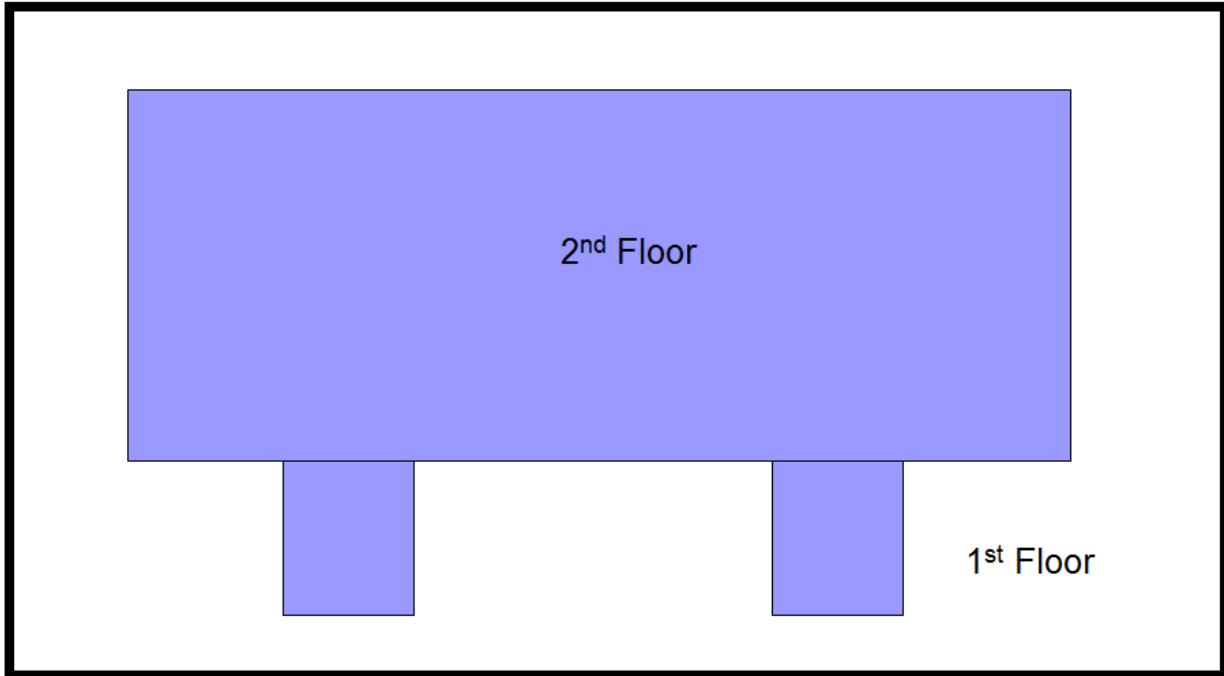

This example will provide a visual understanding of all possible wall adjustment applications. We will begin by viewing the perimeter of the second story. In order to understand the interior to exterior adjustment, an interior wall is added along each perimeter wall. This allows for a visual understanding of each adjustment.

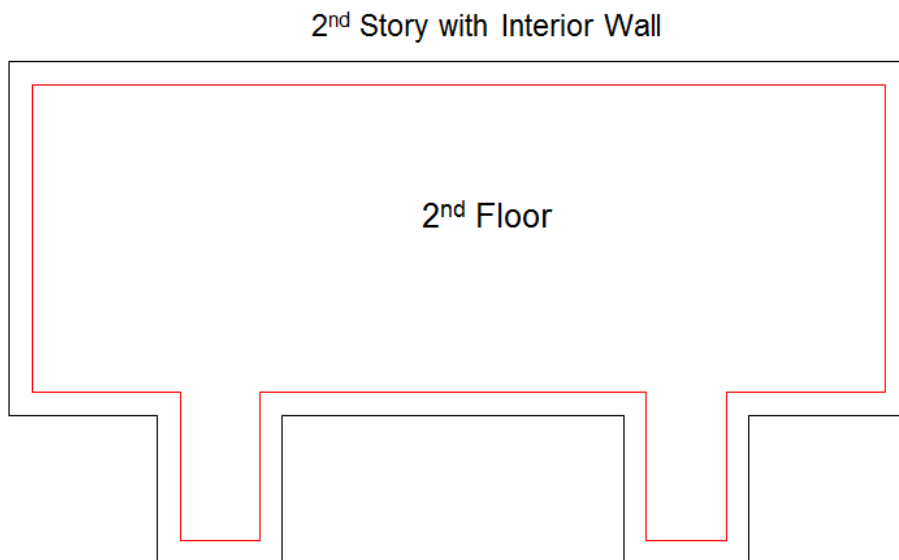

The first adjustment demonstrated is when the interior dimension along the full length of a perimeter wall extends from inside wall to inside wall. Observe the green line designated as "a" in the following diagram.

In order to compute area, the agent needs to convert this interior dimension to reflect the distance from the outside, designated by the red line.

Question: *How many wall thicknesses do we need to adjust to equate the interior dimension to the exterior dimension?*

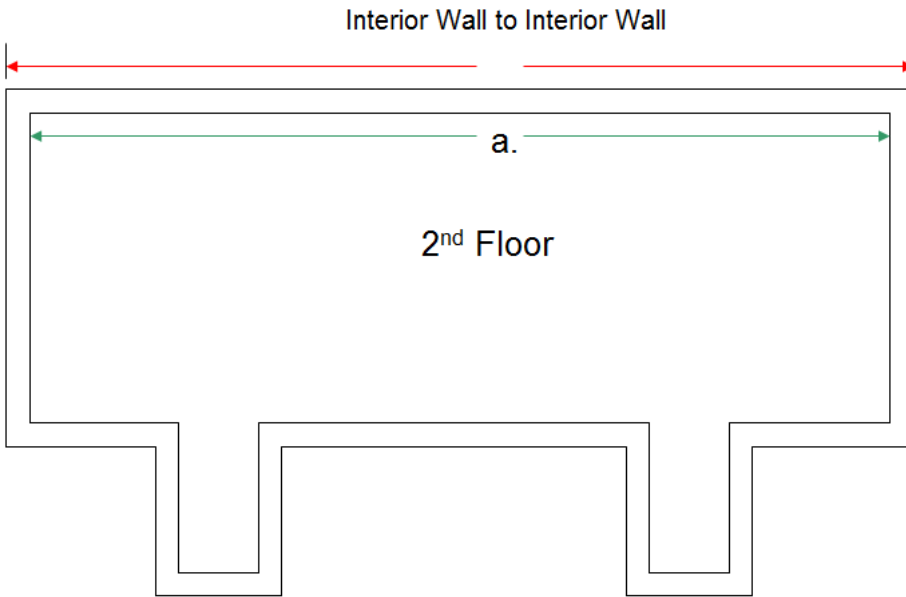

Answer: *2 perimeter wall thicknesses*

Now let's look at another perimeter wall dimension. In this instance look at the interior dimension designated as green line "b". The dimension extends from an interior corner to an interior wall.

Question: *How many wall thicknesses do we need to adjust to equate the interior dimension to the exterior dimension?*

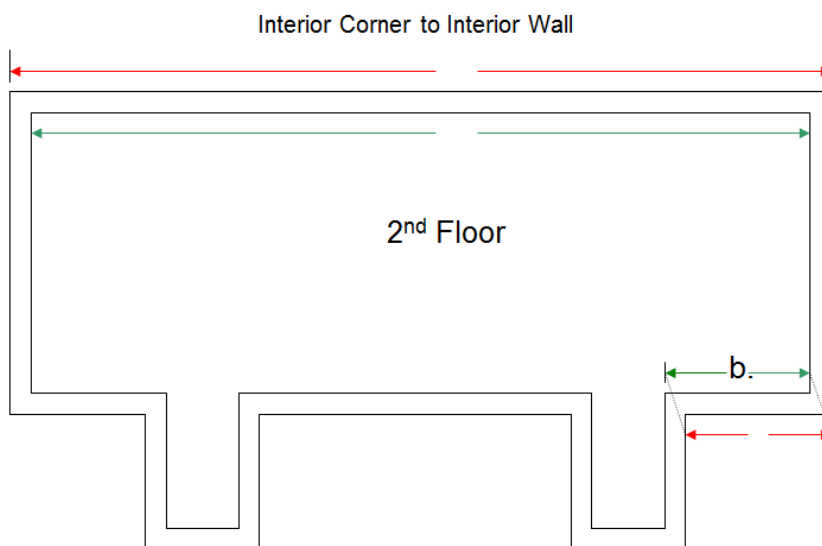

Answer: 0 perimeter wall thicknesses. Both the interior and exterior dimensions are equal in length. This is the same method of determining the length of a dormer. The dimension is a similar interior corner to interior wall pull, which can be placed as an outside dimension without adjustment.

The final potential adjustment is when the interior dimension is pulled from the interior corner to an interior corner along a perimeter wall. Review the following diagram.

Question: What is the adjustment from interior to exterior or from green line "c" to the exterior red line?

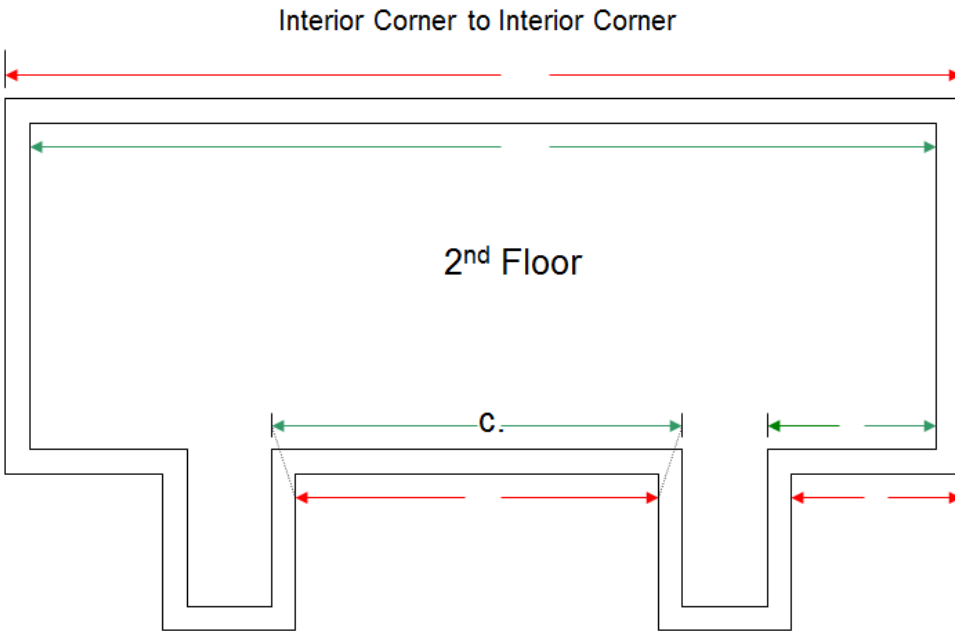

Answer: Deduct 2 wall thicknesses.

Drawing the interior perimeter wall provides visual support for all possible adjustments. This example is a visual addressing all three possibilities.

To review:

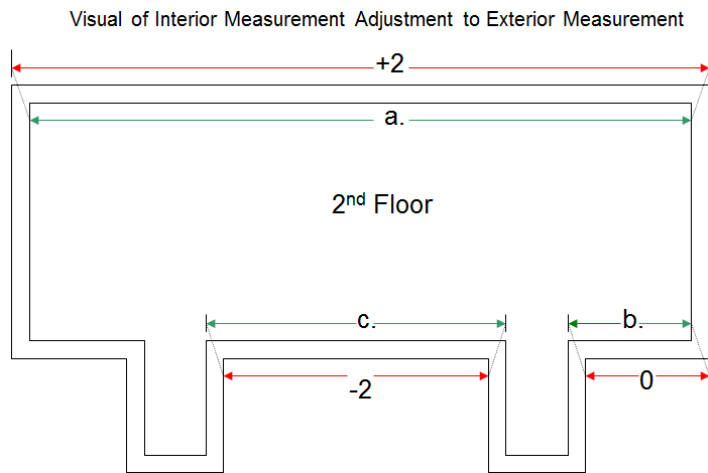

Verbally the adjustment rules can be written as follows:

Convert Interior to Exterior

- a. ■ Interior Wall to Interior Wall ■ Add 2 wall thicknesses
- b. ■ Interior Corner to Interior Wall ■ No adjustment necessary
- c. ■ Interior Corner to Interior Corner ■ Deduct 2 wall thicknesses

Fireplace:

A fireplace that is situated in a corner of the house is included in the living area, as the exterior of the house was measured. A fireplace that protrudes from the exterior of the house should not be included in the living area per the ANSI standard. However, per ANSI, if the hearth is on the first level and the chimney extends through the **interior** of the second level without a hearth on the second level, no deduction is made from the finished square footage of the second level. Market norms may differ in the treatment of a fireplace that protrudes beyond the exterior wall, however, the ANSI standard is clear.

Condominium

The ANSI standard does not address area classification and computation of a condominium, only attached and detached single family houses. A condominium differs from a single family house in ownership interest. The Appraisal Institute's, *The Dictionary of Real Estate Appraisal*, 5th edition, defines a condominium as:

1. A form of ownership in which each owner possess the exclusive right to use and occupy an allotted unit plus an undivided interest in common areas.
2. A multi-unit structure or a unit within such a structure, with a condominium form of ownership.

Thus, in condominium ownership, the owner has rights to a unit or portions of multi-unit buildings. In residential structures, the owner typically holds title to an individual unit and an undivided partial interest in the common areas of the total condominium project.

From a measurement perspective, the reported area of the unit is computed by measuring the interior of the individual unit only. Thus, interior dimensions are not converted to exterior dimensions.

Understand that the name of the development does not verify that the unit is a condominium versus a townhouse. The only way to verify the legal entity is to obtain the recorded property description and declaration. The only obvious indication that a property is a condominium as opposed to an attached single family house is if the units are stacked. Remember, in a single family house, ownership extends from the base to the roof.

It is imperative that an agent/broker determine the legal description of the house or unit to determine whether it is classified as a house covered by the ANSI standards, or a condominium. The area calculations are different.

The following figure is a four unit condominium. If the subject of your listing is Unit D, measurement consists of interior dimensions only in order to determine area.

CONDOMINIUM MEASUREMENT: Interior Wall to Interior Wall

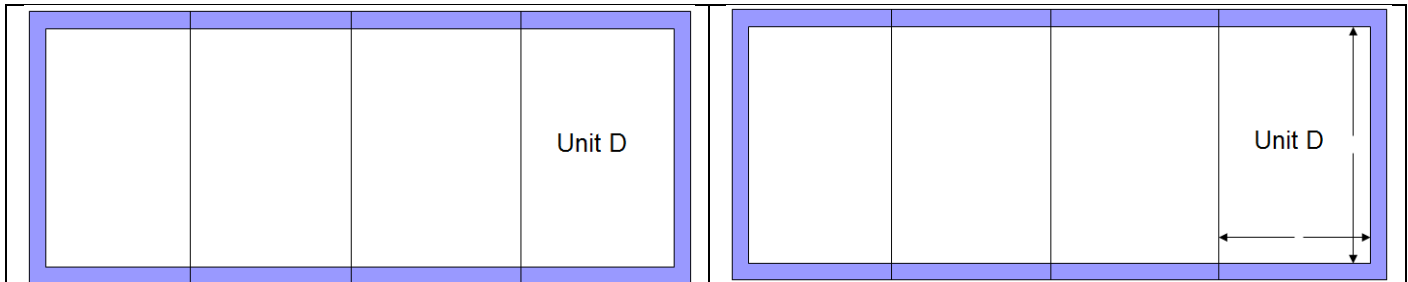

Caution: The property can look like an attached single family house (townhouse) and legally be a condominium. The legal description is the only method of determining the correct property type.